

# COLOR LUX<sup>®</sup>

Roller Shades / Cellular Shades / Roman Shades  
Panel Track Shades / Sheer Shadings



Now  
Available

**COLOR LUX<sup>®</sup>**  
**SHANGRI-LA<sup>®</sup>**  
**SHEER**  
**HORIZONTAL**  
**SHADINGS**

# 2019

**Manufacturer's Price List and Reference Guide** | *Effective February 1, 2019*

**MDS** Midwest  
WINDOW FASHIONS Designer  
Supply

[www.midwestdesignersupply.com](http://www.midwestdesignersupply.com)

888-523-2611  
262-524-1007 (fax)



**Comfortex**  
WINDOW FASHIONS

# Comfortex Color Lux® Cellular, Roller, Panel Track Shades and Shangri-La® Sheer Horizontal Shadings

## Price List and Reference Guide | Effective February 1, 2019

This price list and reference guide contains product pricing, product specifications and technical information for the complete line of Comfortex Color Lux Cellular, Roller, Panel Track and Sheer Shadings.

Color Lux Cellular Shades	Page
Hardware Options . . . . .	1-2
Size Standards . . . . .	3-5
Shade Stack Heights . . . . .	6
Pricing Examples . . . . .	6
Hardware Upgrades and Surcharges . . . . .	7

### Color Lux Cellular Shades Pricing

<b>Standard Rectangular</b> - Color Lux Linen Weave, Verona Textures & Boutique Light Filtering . . . . .	<b>Price Group 1</b> . . . . .	8
<b>Standard Rectangular</b> - Color Lux Linen Weave, Verona Textures & Boutique Room Darkening . . . . .	<b>Price Group 2</b> . . . . .	9
<b>Ovation™ Cellular Sliders</b> - Color Lux Linen Weave, Verona Textures & Boutique Light Filtering and Color Lux Linen Weave, Verona Textures & Boutique Room Darkening . . . . .	<b>Price Group 3 &amp; 4</b> . . . . .	10
<b>Starburst Non-Movable &amp; Movable Arches - Non-Movable &amp; Movable Quarter Rounds</b> - Color Lux Linen Weave, Verona Textures & Boutique Light Filtering and Color Lux Linen Weave, Verona Textures & Boutique Room Darkening . . . . .	<b>Price Group 5 &amp; 6</b> . . . . .	11
<b>Sunset™ Movable Arches</b> - Color Lux Linen Weave, Verona Textures & Boutique Light Filtering and Color Lux Linen Weave, Verona Textures & Boutique Room Darkening . . . . .	<b>Price Group 7 &amp; 8</b> . . . . .	12
<b>Trapezoids and Octagons</b> - Color Lux Linen Weave, Verona Textures & Boutique light Filtering and Color Lux Linen Weave, Verona Textures & Boutique Room Darkening . . . . .	<b>Price Group 9 &amp; 10</b> . . . . .	13
<b>Mezzo Motorized Skylights</b> - Color Lux Linen Weave, Verona Textures & Boutique Light Filtering and Color Lux Linen Weave, Verona Textures & Boutique Room Darkening . . . . .	<b>Price Group 11 &amp; 12</b> . . . . .	14
<b>Non-Movable Door Decor</b> - Color Lux Linen Weave, Verona Textures & Boutique Light Filtering and Color Lux Linen Weave, Verona Textures & Boutique Room Darkening . . . . .	<b>Price Group 13 &amp; 14</b> . . . . .	15
<b>Movable Door Decor</b> - Color Lux Linen Weave, Verona Textures & Boutique Light Filtering and Color Lux Linen Weave, Verona Textures & Boutique Room Darkening . . . . .	<b>Price Group 15 &amp; 16</b> . . . . .	16

### Color Lux Cellular Shades Hardware

Standard Cord Lock Shades . . . . .	17-18
Cord Loop Hardware System . . . . .	19-20
Cordless Ultra™ Hardware System . . . . .	21-22
Cordless Lift & Lock Hardware System . . . . .	23-24
Motorized Shades (including Rechargeable Battery Motorization) . . . . .	25-32
Motorized Top Down-Bottom Up Shades . . . . .	28-29
Simplicity Smart Controller . . . . .	30
PowerTouch Rechargeable Motorized Shades . . . . .	31-32

	<b>Page</b>
Ovation Cellular Sliders . . . . .	33-34
Simplicity Wave Rechargeable Motorized Shades . . . . .	35-36
Insulating SlumberShades . . . . .	37-38
StrataView Shades . . . . .	39-40
Starburst Arches . . . . .	41
Quarter Rounds . . . . .	42-43
Sunset Arches. . . . .	44-45
Trapezoids and Octagons . . . . .	46-47
Mezzo Motorized Skylight Shades . . . . .	49-50
Door Decor . . . . .	51-52
Day-Night Shades. . . . .	53-54
Highlights Cornice Valance . . . . .	55

## **Color Lux Roller Shades**

Key Features for Roller Hardware Options . . . . .	57-58
Skyline Hardware Roller Shades . . . . .	59-60
Color Lux Fabric Information and Fire Rating . . . . .	61

## **Color Lux Roller Shades Pricing**

Color Lux Classic Duck Light Filtering . . . . .	<b>Price Group 17</b> . . . . .	62
Color Lux Classic Duck Blackout . . . . .	<b>Price Group 18</b> . . . . .	63
Color Lux Linen Light Filtering . . . . .	<b>Price Group 19</b> . . . . .	64
Color Lux Linen Blackout . . . . .	<b>Price Group 20</b> . . . . .	65
Color Lux Solar Screen 5 . . . . .	<b>Price Group 21</b> . . . . .	66

## **Color Lux Roller Shades Hardware**

Skyline Standard Roller . . . . .	67
Skyline Hardware Tensioner Information . . . . .	68
Cord Loop Information . . . . .	68
Cordless Roller with Deco-Bar Hardware . . . . .	69
Cordless Options . . . . .	70
Tassels and Pulls. . . . .	71
General Information . . . . .	72
Designer Cassette with Insert Strip . . . . .	73
Designer Cassette with Fabric Wrap . . . . .	73
Designer Cassette with Smooth Face . . . . .	73
Two-on-One Head Rail . . . . .	74
Dual Roller with Skyline Cord Loop & Motorization Hardware . . . . .	75
Designer Cassette with Retractable Cord . . . . .	77
Designer Cassette with Simplicity Rechargeable Wave . . . . .	79
Four Inch Skyline Fascia . . . . .	81
Designer Cassette & No Head Rail with PowerTouch Rechargeable . . . . .	83
Simplicity Rechargeable Motorization . . . . .	85
Simplicity 5 Channel Remote Information . . . . .	87
Simplicity 6 Channel Timer Remote Information . . . . .	87
Simplicity 14 Channel Remote Information . . . . .	87
Highlights Cornice Valance with Keystone . . . . .	88

## Color Lux Panel Track System Shades

Features and Benefits of the Panel Track System . . . . .	92
Stacking Options . . . . .	92
Panel Attachment Method . . . . .	92
Head Rail Colors . . . . .	92
Bottom Rail Style . . . . .	92
Fabric Panel Information . . . . .	92
Panel Custom Overlaps . . . . .	92
Control Options . . . . .	93
Panel Widths . . . . .	93
Head Rail Splicing . . . . .	93
Track Specifications . . . . .	93

## Color Lux Panel Track System Shades Pricing

Includes Classic Duck Light Filtering, Classic Duck Blackout, Linen Light Filtering, Linen Blackout, and Solar Screen 5 . . . . .	<b>Grid 22 &amp; 23</b> . . . . .	94
--	-----------------------------------	----

## Color Lux Panel Track System Shades Specifications

Finished Dimensions . . . . .	95
Mounting Options . . . . .	95
Panel Stack Back . . . . .	95
Light Gap . . . . .	95
Fabric Deductions and Specifications . . . . .	95
Highlights Valance . . . . .	95
Clear Window Opening and Stack Panels . . . . .	96
Outside Mount Hardware Profiles . . . . .	97
Inside Mount Hardware Profiles . . . . .	98

## Color Lux Custom Graphics

General Information and How to Order . . . . .	100-101
--	---------

## Color Lux Custom Graphics Pricing

Classic Duck Light Filtering . . . . .	<b>Price Group 24</b> . . . . .	102
Classic Duck Blackout . . . . .	<b>Price Group 25</b> . . . . .	102
E Screen 5% . . . . .	<b>Price Group 26</b> . . . . .	103

## Color Lux Shangri-La Sheer Horizontal Shadings

Features At A Glance . . . . .	104
Key Features . . . . .	105-106
Fabric Collections and Vane Sizes . . . . .	107
Fabric Collection Size Standards . . . . .	108-110
Hardware Upgrades and Surcharges . . . . .	111

## Color Lux Shangri-La Sheer Horizontal Shadings Pricing

3" Light Filtering . . . . .	<b>Price Group 27</b> . . . . .	112
3" Room Darkening . . . . .	<b>Price Group 28</b> . . . . .	112
3" DoorStyles Light Filtering . . . . .	<b>Price Group 29</b> . . . . .	113
3" DoorStyles Room Darkening . . . . .	<b>Price Group 30</b> . . . . .	113

## Color Lux Shangri-La Sheer Horizontal Shadings Hardware

Cord Loop Designer Cassette Head Rail: . . . . .	114-115
Cord Information for Color Lux Shangri-La Sheer Horizontal Shadings. . . . .	115
Reverse Roll . . . . .	115
Length Considerations with Color Lux Shangri-La Sheer Horizontal Shadings . . . . .	115
Side by Side Alignment . . . . .	115
Omni-View System . . . . .	115
Retractable Cord . . . . .	116
Two-On-One . . . . .	117
Cordless . . . . .	118-119
DoorStyles . . . . .	120-121
PowerTouch Rechargeable. . . . .	122-123
Simplicity Integrated Rechargeable . . . . .	124-126
Solar Panel Recharge Option . . . . .	126
Simplicity Smart Controller . . . . .	127
Certified Fabrics . . . . .	128
Flame Resistance . . . . .	128
UV Protection . . . . .	128
Vane Opening and Visibility . . . . .	128
Vane Closure . . . . .	128
Leveling Color Lux Shangri-La Sheer Horizontal Shadings . . . . .	128
Measuring Instructions for Color Lux Shangri-La Sheer Horizontal Shadings . . . . .	129
Skew Adjusting Bottom Rail . . . . .	129
Cleaning and Care . . . . .	129

## Color Lux General Information

Cut-Outs, Scotchgard™ Protection and Certified Fabrics . . . . .	131
Highlights Cornice Valances . . . . .	131
Stack Heights . . . . .	131
Child Safety . . . . .	132
Cleaning and Care . . . . .	132
Measuring Instructions. . . . .	133
Making Template . . . . .	133
Conditions of Sale . . . . .	134
Policies . . . . .	134
Scotchgard™ Warranty. . . . .	135
Color Lux Warranty Information . . . . .	135-136
Motorized Color Lux Shades/Shadings Warranty. . . . .	136



## COLOR LUX® CELLULAR SHADES



**COLOR LUX™**  
*Designer Cellular & Roller Shades*









### **Scotchgard™ Protection**

Optional Scotchgard™ Protector is available with Color Lux Linen Shades. Scotchgard™ keeps your shades looking newer, fresher and cleaner longer.

A combination of the latest advances in stain release and repellency provides exceptional stain protection. Spills wipe away easily and most dirt and stains lift out when cleaned.







# Color Lux® Cellular Shades

## HARDWARE OPTIONS

	Key Features	Hardware Options	Hardware Size (Depth x Height)	Shade Size Available*	More Information
<b>Standard Cord Lock</b> 	<ul style="list-style-type: none"> <li>• Proven cord lock</li> <li>• Sleek, fabric wrapped rails</li> <li>• UV resistant cords</li> </ul>	<ul style="list-style-type: none"> <li>• Fabric Wrapped</li> <li>• Brushed Nickel</li> <li>• Oil Rubbed Bronze</li> </ul>	2¾" x ½"	Width: 8" to 108"  Length: 8" to 120"	Page 17
<b>Cord Loop</b> 	<ul style="list-style-type: none"> <li>• Cord Loop makes operation easy</li> <li>• Smooth &amp; quiet operation</li> </ul>	<ul style="list-style-type: none"> <li>• Fabric Wrapped</li> <li>• Brushed Nickel</li> <li>• Oil Rubbed Bronze</li> </ul>	2¼" x 1½"	Width: 14" to 108"  Length: 8" to 120"	Page 19
<b>Cordless Ultra</b> 	<ul style="list-style-type: none"> <li>• Child safe</li> <li>• No visible cords</li> <li>• Smooth &amp; quiet operation</li> </ul>	<ul style="list-style-type: none"> <li>• Fabric Wrapped</li> <li>• Brushed Nickel</li> <li>• Oil Rubbed Bronze</li> </ul>	2¼" x 1½"	Width: 18" to 108"  Length: 8" to 84"	Page 21
<b>Cordless Lift &amp; Lock</b> 	<ul style="list-style-type: none"> <li>• Child safe</li> <li>• Easy push button operation</li> <li>• Rails lock securely in place in any position</li> </ul>	<ul style="list-style-type: none"> <li>• Fabric Wrapped</li> <li>• Oil Rubbed Bronze</li> </ul>	2¾" x ½"  Bottom Rail: 1⅞" x 1⅞"	Width: 16" to 96"  Length: 8" to 84"	Page 23
<b>Rechargeable Simplicity Motorization</b> 	<ul style="list-style-type: none"> <li>• Features a battery powered motor utilizing a rechargeable battery pack</li> <li>• Raise &amp; lower shade with click of a button</li> <li>• Great for large and hard to reach windows</li> <li>• Remote can operate multiple shades</li> </ul>	<ul style="list-style-type: none"> <li>• Fabric Wrapped</li> <li>• Oil Rubbed Bronze</li> </ul>	2¼" x 1½"	Width: 18" to 96"  Length: 8" to 120"	Page 25
<b>PowerTouch Rechargeable</b> 	<ul style="list-style-type: none"> <li>• Raise &amp; lower shade with push of a button</li> <li>• Eliminate the need to stand by the shade to operate; just touch and go</li> <li>• Favorite position button</li> <li>• Rechargeable battery pack with recharge port on pendant</li> </ul>	<ul style="list-style-type: none"> <li>• Wand and pendant available in white or black</li> </ul>	2¼" x 1½"	Width: 18" to 96"  Length: 8" to 120"	Page 31

\* Maximum widths and lengths listed do not take into account square foot or weight limitations. Make sure to refer to shaded areas on price groups for maximum size availability by fabric style.

**Color Lux® Cellular Shades**  
**HARDWARE OPTIONS**

	Key Features	Color Options	Hardware Size (Depth x Height)	Shade Size Available*	More Information
<p><b>Simplicity Wave Rechargeable Motorization</b></p> 	<ul style="list-style-type: none"> <li>• Features a battery powered motor utilizing a rechargeable battery</li> <li>• Raise &amp; lower shade with the wave of a wand</li> <li>• Great for out of reach windows</li> <li>• Exact match soft fabric wrapped rails</li> </ul>	<ul style="list-style-type: none"> <li>• Fabric Wrapped</li> </ul>	2¼" x 1½"	<p>Width: 17½" to 96"</p> <p>Length: 12" to 120"</p>	Page 35
<p><b>Ovation™ Slider</b></p> 	<ul style="list-style-type: none"> <li>• Vertically oriented fabric glides across window</li> <li>• Shade can stack left, right or center</li> <li>• Great for sliding glass doors or room dividers</li> </ul>	<ul style="list-style-type: none"> <li>• White (Standard)</li> <li>• Ivory</li> <li>• Beige</li> <li>• Tan</li> <li>• Gray</li> </ul>	3⅝" x 1¾"	<p>Width: 12" to 168"</p> <p>Length: 24" to 108"</p>	Page 33
<p><b>Door Décor</b></p> 	<ul style="list-style-type: none"> <li>• Great option for narrow windows and doors</li> <li>• Available in movable &amp; non-movable rails</li> <li>• No Pull cords</li> </ul>	<ul style="list-style-type: none"> <li>• Fabric Wrapped</li> <li>• Brushed Nickel</li> <li>• Oil Rubbed Bronze</li> </ul>	2⅜" x ½"	<p>Width: 3" to 36"</p> <p>Length: 12" to 96"</p>	Page 51
<p><b>Top Down-Bottom Up</b></p> 	<ul style="list-style-type: none"> <li>• Lower shade from top: raise from bottom</li> <li>• Great for privacy</li> <li>• Ideal for light control</li> <li>• <b>NEW!</b> Motorization Available</li> </ul>	<ul style="list-style-type: none"> <li>• Fabric Wrapped</li> <li>• Oil Rubbed Bronze</li> </ul>	2⅜" x ½"	<p>Width: 18" to 108"</p> <p>Length: 8" to 120"</p>	See Product Availability Page 17-24
<p><b>Two on One Head Rail</b></p> 	<ul style="list-style-type: none"> <li>• Operate two shades on one rail</li> <li>• Great for larger windows</li> <li>• Individually operating shades</li> </ul>	<ul style="list-style-type: none"> <li>• Fabric Wrapped</li> <li>• Oil Rubbed Bronze</li> </ul>	Dependent on Hardware Chosen See Above	<p>Width: 16" to 144"</p> <p>Length: 8" to 120"</p>	See Product Availability Page 17-20
<p><b>Highlights Cornice Valance</b></p> 	<ul style="list-style-type: none"> <li>• Adds height to windows and hides hardware</li> <li>• Available as inside and outside mount</li> <li>• Easy to install</li> </ul>	<ul style="list-style-type: none"> <li>• All Color Lux Roller Fabrics</li> <li>• All Envision Roller Fabrics</li> </ul>	<p>Width: 24" to 216"</p> <p>Height: 6"</p> <p>Returns: 1½" to 6"</p>	<p>Varies by selected fabric</p> <p>Width: 12" to 94"</p>	Page 55
<p><b>Insulating SlumberShade™</b></p> 	<ul style="list-style-type: none"> <li>• Ultimate blackout shade</li> <li>• Tracks keep out light, cold or heat</li> <li>• Perfect for nurseries, day sleepers</li> <li>• Note: Not available on Boutique fabrics</li> </ul>	<ul style="list-style-type: none"> <li>• Fabric Wrapped</li> <li>• Brushed Nickel</li> <li>• Oil Rubbed Bronze</li> <li>• Sidetracks are available in white, tan or black</li> </ul>	Dependant on hardware choice	<p>Width: 9" to 96"</p> <p>Length: 8" to 120"</p>	Page 37

\* Maximum widths and lengths listed do not take into account square foot or weight limitations. Make sure to refer to shaded areas on price groups for maximum size availability by fabric style.



**Color Lux® Cellular Shades**  
**SIZE STANDARDS**

COLORLUX® CELLULAR SHADES



				Cord Lock		Cord Loop		Cordless Ultra		Cordless Lift & Lock	
Minimum				Standard	TD-BU	Standard	TD-BU <sup>+</sup>	Standard	TD-BU <sup>+</sup>	Standard	TD-BU
<b>COLOR LUX® FABRICS</b>				Min. Width	8" 12"	14" 22"	15" OB 18" OB 15 3/8" IB 18 3/8" IB	16" OB 20" OB 16 3/8" IB 20 3/8" IB			
				Min. Length	8" 8"	8" 8"	8" 8"				
* <b>Linen Weave, Verona Textures &amp; Boutique</b>				Cord Lock		Cord Loop		Cordless Ultra		Cordless Lift & Lock	
<b>Price Group</b>	<b>Page</b>			Standard	TD-BU	Standard	TD-BU <sup>+</sup>	Standard	TD-BU <sup>+</sup>	Standard	TD-BU
<b>Light Filtering</b>	1	8	Maximum Width & Length	108" width 120" length	96" width 96" length	108" width 120" length	108" width 120" length	108" width 84" length	96" width 84" length	96" width 84" length	96" width 84" length
<b>Room Darkening</b>	2	9	Maximum Width & Length	108" width 120" length	84" width 96" length	108" width 120" length	108" width 120" length	108" width 84" length	96" width 84" length	96" width 84" length	96" width 84" length
				Cord Lock		Cord Loop		Cordless Ultra		Cordless Lift & Lock	
Stacking Heights Information On Page More Information On Page				Page 6 Page 17		Page 6 Page 19		Page 6 Page 21		Page 6 Page 23	

+ Maximum Width & Length and Minimum Width & Length applies to StrataView Shades



				Motorization		Motorization		Two-On-One Head Rail		Ovation	
Minimum				Simplicity+	Simplicity Wave	PowerTouch Rechargeable	Cord Lock*	Cord Loop/Cordless**	Standard		
<b>COLOR LUX® FABRICS</b>				Minimum Width	18" OB 18 3/8" IB	17 3/8"	18" OB 18 3/8" IB	16"	36"	12"	
				Min. Length	8" 12"	8"	8"	8"	8"	24"	
<b>Linen Weave, Verona Textures &amp; Boutique</b>				Motorization		Motorization		Two-On-One Head Rail		Ovation	
<b>Price Group</b>	<b>Page</b>			Simplicity~	Simplicity Wave	PowerTouch Rechargeable	Cord Lock*	Cord Loop/Cordless**	Standard		
<b>Light Filtering</b>			Maximum Width & Length	108" width 120" length	96" width 120" length	108" width 120" length	144" width 120" length	144" width 120" length	120" width*** 108" length		
<b>Room Darkening</b>			Maximum Width & Length	108" width 120" length	96" width 120" length	108" width 120" length	144" width 120" length	144" width 120" length	120" width*** 108" length		
				Motorization		Motorization		Two-On-One Head Rail		Ovation	
				Simplicity	Simplicity Wave	PowerTouch Rechargeable	Cord Lock	Cord Loop/Cordless	Standard		
Stacking Heights Information On Page More Information On Page				Page 6 Page 25-32		Page 6 Page 31		Page 6 Page 17-21		Page 6 Page 33	

Motorized shades less than 24" in width are limited to a maximum of 60" in length.

Maximum widths and lengths listed do not take into account square foot or weight limitations. Make sure to refer to shaded areas on price groups for maximum size availability by fabric style. \* Minimum single panel is 8", maximum single panel is 108". \*\* Minimum single panel is 18", maximum single panel is 108". \*\*\* Split stack sliders are available is 240", however if the width exceeds 120", the shade will be fabricated as two separate sliders. Supplied valance will create the appearance of a single slider. + Minimum for Motorized Top Down-Bottom Up is 24" IB and 23 5/8" OB. Minimum length and maximum length and width are the same as Simplicity motorization specs.

**Color Lux® Cellular Shades**  
**SIZE STANDARDS**



		SlumberShade Cord Lock		SlumberShade Cord Loop		SlumberShade Cordless	
		Bottom Up	Top Down Bottom Up	Bottom Up	Top Down Bottom Up	Bottom Up	Top Down Bottom Up
<b>LINEN WEAVE FABRICS</b> (not available in Boutique fabrics)	Minimum Width	9"	13"	15"	25"	16" IB	19"
	Min. Length	8"	8"	8"	8"	8"	8"

				SlumberShade Cord Lock		SlumberShade Cord Loop		SlumberShade Cordless	
				Bottom Up	Top Down Bottom Up	Bottom Up	Top Down Bottom Up	Bottom Up	Top Down Bottom Up
<b>Light Filtering</b>	<b>Price Group</b>	<b>Page</b>							
<b>Linen Weave Verona Textures</b>	1	8	Maximum Width & Length  Refer to shaded area in price grids for max size (sq ft) by fabric style	96" width 120" length	96" width 96" length	96" width 120" length	96" width 120" length	96" width 84" length	96" width 84" length

				SlumberShade Cord Lock		SlumberShade Cord Loop		SlumberShade Cordless	
				Bottom Up	Top Down Bottom Up	Bottom Up	Top Down Bottom Up	Bottom Up	Top Down Bottom Up
<b>Room Darkening &amp; Blackout</b>	<b>Price Group</b>	<b>Page</b>							
<b>Linen Weave Verona Textures</b>	2	9	Maximum Width & Length  Refer to shaded area in price grids for max size (sq ft) by fabric style	96" width 120" length	84" width 96" length	96" width 120" length	96" width 120" length	96" width 84" length	96" width 84" length

				SlumberShade Cord Lock		SlumberShade Cord Loop		SlumberShade Cordless	
				Bottom Up	Top Down Bottom Up	Bottom Up	Top Down Bottom Up	Bottom Up	Top Down Bottom Up
Stacking Heights Information On Page More Information On Page				Page 6 Page 37-38		Page 6 Page 37-38		Page 6 Page 37-38	

Please Note: For any shades under 12" width, the maximum height is 80".

**Color Lux® Cellular Shades**  
**SIZE STANDARDS**

COLORLUX® CELLULAR SHADES

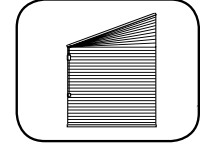
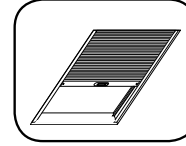
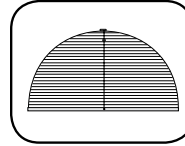
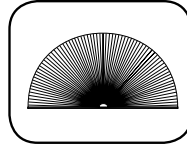

		Starburst Arch	Sunset Arch	Mezzo Skylight	Trapezoid
Minimum		Non-Movable/Movable	Movable	Motorized	Standard
<b>COLOR LUX® FABRICS</b>	Min. Width	18"	18"	18"	12"
	Min. Length	9"	6"	12"	12"
		Starburst Arch	Sunset Arch	Mezzo Skylight	Trapezoid
Linen Weave, Verona Textures & Boutique		Non-Movable/Movable	Movable	Motorized	Standard
<b>Light Filtering</b>	Maximum Width & Length	72" x 36"	72" x 60"	48" x 72"	48" x 72"
<b>Room Darkening</b>	Maximum Width & Length	72" x 36"	60" x 60"	48" x 72"	48" x 72"
		Starburst Arch	Sunset Arch	Mezzo Skylight	Trapezoid
		Non-Movable/Movable	Movable	Motorized	Standard
Stacking Heights Information On Page More Information On Page		Page 6 Page 41	Page 6 Page 44	Page 6 Page 48	Page 6 Page 46

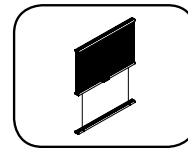
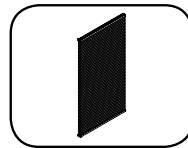
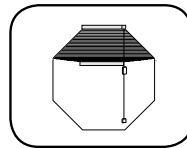

		Octagon	French Door Décor	
Minimum		Standard	Non-Movable	Movable
<b>COLOR LUX® FABRICS</b>	Minimum Width	12"	6"	6"
	Min. Length	12"	12"	12"
		Octagon	Door Decor	
Linen Weave, Verona Textures & Boutique		Standard	Non-Movable	Movable
<b>Light Filtering</b>	Maximum Width & Length	48" width 48" length	36" width 96" length	36" width 96" length
<b>Room Darkening</b>	Maximum Width & Length	48" width 48" length	36" width 96" length	36" width 96" length
		Octagon	Door Decor	
		Standard	Non-Movable	Movable
Stacking Heights Information On Page More Information On Page		Page 6 Page 46	Page 6 Page 51	Page 6 Page 51

# Color Lux® Cellular Shades

## SHADE STACK HEIGHTS

Measurements are in inches. Shade stacking heights applicable when the shade is in the fully raised position.

<b>RECTANGULAR CORD LOCK - Includes head and bottom rails</b>	<b>48"</b>	<b>72"</b>	<b>84"</b>	<b>96"</b>
Linen Weave, Verona Textures & Boutique Light Filtering and Room Darkening Fabrics	2"	2 <sup>3</sup> / <sub>8</sub> "	2 <sup>5</sup> / <sub>8</sub> "	2 <sup>7</sup> / <sub>8</sub> "

For Top Down-Bottom Up, add <sup>3</sup>/<sub>8</sub>"

<b>CORD LOOP - CORDLESS ULTRA - MOTORIZATION - Includes head and bottom rails</b>	<b>48"</b>	<b>72"</b>	<b>84"</b>	<b>96"</b>
Linen Weave, Verona Textures & Boutique Light Filtering and Room Darkening Fabrics	3"	3 <sup>3</sup> / <sub>8</sub> "	3 <sup>5</sup> / <sub>8</sub> "	3 <sup>7</sup> / <sub>8</sub> "
StrataView™	4 <sup>3</sup> / <sub>8</sub> "	5 <sup>1</sup> / <sub>2</sub> "	6"	6 <sup>1</sup> / <sub>2</sub> "

<b>CORDLESS LIFT &amp; LOCK - Includes head and bottom rails</b>	<b>48"</b>	<b>60"</b>	<b>72"</b>	<b>84"</b>
Linen Weave, Verona Textures & Boutique Light Filtering and Room Darkening Fabrics	2 <sup>3</sup> / <sub>4</sub> "	3 <sup>1</sup> / <sub>8</sub> "	3 <sup>3</sup> / <sub>8</sub> "	3 <sup>5</sup> / <sub>8</sub> "

For Top Down-Bottom Up, add 1<sup>1</sup>/<sub>4</sub>"

<b>OVATION</b>	<b>84"</b>	<b>96"</b>	<b>108"</b>	<b>120"</b>
Linen Weave, Verona Textures & Boutique Light Filtering and Room Darkening Fabrics	6 <sup>1</sup> / <sub>2</sub> "	7 <sup>1</sup> / <sub>4</sub> "	8"	8 <sup>3</sup> / <sub>4</sub> "

Ovations minimum fabric stack measures 6<sup>1</sup>/<sub>2</sub>" regardless of the ordered width. Fabric stacking dimensions are determined by the slider's hardware, not ordered width.

### Color Lux Cellular Shade Pricing Examples

#### Rechargeable Simplicity Pricing Example:

Linen Weave	
Light Filtering 42" x 60" Shade:	\$407.00
Simplicity Rechargeable Motor Surcharge:	\$368.00
Charger for Rechargeable:	\$30.00
Simplicity 5 Channel Remote Control:	\$44.00
<b>Total List Price:</b>	<b>\$849.00</b>

#### Motorized Top Down-Bottom Up Pricing Example:

Linen Weave	
Light Filtering 42" x 60" Shade:	\$407.00
Simplicity Rechargeable TDBU Surcharge:	\$589.00
Charger for Rechargeable:	\$30.00
TDBU Remote Control:	\$72.00
<b>Total List Price:</b>	<b>\$1098.00</b>

#### PowerTouch Rechargeable Pricing Example:

Linen Weave	
Light Filtering 42" x 60" Shade:	\$407.00
PowerTouch Rechargeable Surcharge:	\$132.00
Charger for Rechargeable:	\$30.00
<b>Total List Price:</b>	<b>\$569.00</b>

#### StrataView Motorization Pricing Example:

Linen Weave	
Light Filtering 42" x 60" Shade:	\$407.00
Simplicity Rechargeable Surcharge:	\$786.00
Charger for Rechargeable:	\$30.00
TDBU Remote Control:	\$72.00
<b>Total List Price:</b>	<b>\$1295.00</b>

# Color Lux® Cellular Shades

## HARDWARE UPGRADE OPTIONS

COLORLUX® CELLULAR SHADES

LIFT SYSTEM	UPGRADES	ADD
Cord Lock	Top Down-Bottom Up	\$68
	Cordless Lift & Lock Surcharge	No Extra Charge
Cordless Ultra	Bottom Up	\$88
	Top Down-Bottom Up	\$175
Cord Loop	Bottom Up	\$88
	Top Down-Bottom Up	\$175

DESIGNER UPGRADE OPTIONS	UPGRADES	ADD
Add to Any Lift System Upgrade (Chart to the left)	Metallic Hardware	No Extra Charge
	Fabric Wrapped Hardware	No Extra Charge
	Scotchgard Stain Protection	\$38
	Highlights Valance See Page 55 For More Information	
Light Blocking Sidetrack System	Insulating SlumberShades See Page 37 For More Information	\$142

ADDITIONAL OPTIONS	UPGRADES	ADD
Add to Any Upgrade Above	Two-On-One Head Rail	\$52 Add to Cord Lock, Cordless or Cord Loop Head Rail
	Cut Outs	\$55 Per side
	Day-Night	Price each panel as separate shade and add together
	StrataView™	\$362 (includes Top Down-Bottom Up & top sheer fabric additions) Available on Cordless Ultra and Cord Loop
	Ovation Center Stack	\$88
Accessories	6 Foot Expandable Pole	\$44
	12 Foot Expandable Pole	\$54

## Cellular Shade Motorized Hardware Upgrade Options

MOTORIZED	UPGRADES	ADD	
PowerTouch Rechargeable Motorization System	Motor and Rechargeable Battery Pack	\$132	For More Information Page 31
	Plug-In Charger for Rechargeable Li-Ion	\$30	
Simplicity Remote Rechargeable Motorization System	Motor and Rechargeable Battery Pack	\$368	For More Information Page 25
	Simplicity 5 Channel Remote	\$44	
	Simplicity 6 Channel Remote/Timer	\$72	
	Plug-In Charger for Rechargeable Li-Ion	\$30	
	NEW StrataView™*	\$786	
	NEW Top Down-Bottom Up**	\$589	
	NEW Top Down-Bottom Up/StrataView 14 Channel Remote***	\$72	
7.4v Solar Panel & Mounting Brackets	\$110		
Simplicity Wave Rechargeable Motorization System	Motor and Rechargeable Battery Pack	\$132	For More Information Page 35
	Telescoping Wand	\$30	
	Plug-In Charger for Rechargeable Li-Ion	\$30	
Simplicity Smart Controller System	NEO Controller	\$363	For More Information Page 30
	NEO Application for Mobile Devices	FREE	

\*Upcharge includes Top Down-Bottom Up surcharge & top sheer fabric addition \$197

\*\*Upcharge includes motorization surcharge of \$334, plus \$201 for second motor and Top Down-Bottom Up components

\*\*\* TDBU Remote required for Motorized Top Down-Bottom Up and StrataView shades



**Color Lux® Cellular Shades**  
**PRICING**

**Color Lux® Linen Weave, Verona Textures & Boutique Light Filtering**

**Price Group 1**

**Cord Lock - Fabric Wrapped or Designer Metallic Rails**  
**Cordless Lift & Lock - Fabric Wrapped or Designer Metallic Rail**

Length In Inches	Width In Inches														
	24	30	36	42	48	54	60	66	72	84	96	108	120	132	144
36	223	246	279	308	338	366	395	420	450	514	575	636	701	762	824
42	237	268	297	333	366	397	432	462	495	565	633	703	778	853	929
48	249	285	323	358	395	430	465	504	540	627	713	799	886	972	1058
54	266	301	342	381	422	461	509	557	606	703	799	896	993	1090	1187
60	281	321	366	407	449	509	563	616	670	778	885	993	1101	1209	1316
66	293	338	387	439	498	557	616	676	735	853	972	1090	1209	1327	1445
72	308	353	407	477	541	606	670	735	799	929	1058	1187	1316	1445	1574
78	323	375	444	514	584	654	724	794	864	1004	1144	1284	1424	1563	1703
84	332	401	477	552	627	703	778	853	929	1079	1230	1381	1531	1681	1832
90	346	428	509	590	670	751	832	912	993	1155	1316	1477	1638	1800	1961
96	369	455	541	627	713	799	885	972	1058	1230	1402	1573	1746	1918	2090
108	412	509	606	703	799	896	993	1090	1187	1381	1573	1767	1961	2155	2349
120	455	563	670	778	885	993	1101	1208	1316	1530	1745	1961	2176	2392	2607

Motorized Lift Systems are not offered within the shaded area.

Widths over 108" must be built as Two-On-One Shades. Surcharge is included in shades over 108" wide

LIFT SYSTEM	UPGRADES	ADD
Cord Lock	Top Down-Bottom Up	\$68
Cordless Lift & Lock Surcharge	Bottom Up	No Extra Charge
	Top Down-Bottom Up	\$88
Cordless Ultra	Bottom Up	\$88
	Top Down-Bottom Up	\$175
Cord Loop	Bottom Up	\$88
	Top Down-Bottom Up	\$175

DESIGNER UPGRADE OPTIONS	UPGRADES	ADD
Add to Any Lift System Upgrade (Chart to the left)	Metallic Hardware	No Extra Charge
	Fabric Wrapped Hardware	No Extra Charge
	Scotchgard Stain Protection	\$38
	Highlights Valance See Page 55 For More Information	

ADDITIONAL OPTIONS	UPGRADES	ADD
Add to Any Upgrade Above	Two-On-One Head Rail	\$52 Add to Cord Lock, Cord Loop, or Cordless Head Rail under 108" widths
	Cut Outs	\$55 Per side
	Day-Night	Price each panel as separate shade and add together
	StrataView™	\$362 (includes Top Down-Bottom Up & top sheer fabric additions)
Accessories	6 Foot Expandable Pole	\$44
	12 Foot Expandable Pole	\$54

MOTORIZATION	MORE INFO
Motorized Pricing Examples - Surcharges - Options	Pg 6
Insulating SlumberShades	\$142 See Page 37 For More Information. Not available with motorization or StrataView.

**Color Lux® Cellular Shades**  
**PRICING**

**Color Lux® Linen Weave, Verona Textures & Boutique Room Darkening**

**Price Group 2**

**Cord Lock - Fabric Wrapped or Designer Metallic Rails**  
**Cordless Lift & Lock - Fabric Wrapped or Designer Metallic Rail**

COLORLUX® CELLULAR SHADES

		Width In Inches														
		24	30	36	42	48	54	60	66	72	84	96	108	120	132	144
Length In Inches	36	290	320	363	401	440	476	514	546	585	669	748	827	962	1041	1122
	42	309	349	387	433	476	517	562	601	644	735	823	914	1062	1159	1258
	48	324	371	420	466	514	559	605	656	702	816	927	1039	1202	1314	1426
	54	346	392	445	496	549	600	662	725	788	914	1039	1165	1341	1467	1594
	60	366	418	476	530	584	662	732	801	871	1012	1151	1291	1482	1622	1761
	66	381	440	504	571	648	725	801	879	956	1109	1264	1417	1622	1776	1929
	72	401	459	530	621	704	788	871	956	1039	1208	1376	1544	1761	1929	2097
	78	420	488	578	669	760	851	942	1033	1124	1306	1488	1670	1902	2082	2264
	84	432	522	621	718	816	914	1012	1109	1208	1403	1599	1796	2041	2236	2432
	90	450	557	662	767	871	977	1082	1186	1291	1502	1711	1921	2180	2390	2600
	96	480	592	704	816	927	1039	1151	1264	1376	1599	1823	2045	2320	2544	2767
	108	536	662	788	914	1039	1165	1291	1417	1544	1796	2045	2298	2600	2852	3104
120	592	732	871	1012	1151	1291	1432	1571	1711	1989	2269	2550	2879	3160	3440	

Motorized Lift Systems are not offered within the shaded area.

Widths over 108" must be built as Two-On-One Shades. Surcharge is included in shades over 108" wide

LIFT SYSTEM	UPGRADES	ADD
Cord Lock	Top Down-Bottom Up	\$68
Cordless Lift & Lock Surcharge	Bottom Up	No Extra Charge
	Top Down-Bottom Up	\$88
Cordless Ultra	Bottom Up	\$88
	Top Down-Bottom Up	\$175
Cord Loop	Bottom Up	\$88
	Top Down-Bottom Up	\$175

DESIGNER UPGRADE OPTIONS	UPGRADES	ADD
Add to Any Lift System Upgrade (Chart to the left)	Metallic Hardware	No Extra Charge
	Fabric Wrapped Hardware	No Extra Charge
	Scotchgard Stain Protection	\$38
	Highlights Valance See Page 55 For More Information	

ADDITIONAL OPTIONS	UPGRADES	ADD
Add to Any Upgrade Above	Two-On-One Head Rail	\$52 Add to Cord Lock, Cord Loop or Cordless Head Rail under 108" widths
	Cut Outs	\$55 Per side
	Day-Night	Price each panel as separate shade and add together
	StrataView™	\$362 (includes Top Down-Bottom Up & top sheer fabric additions)
Accessories	6 Foot Expandable Pole	\$44
	12 Foot Expandable Pole	\$54

MOTORIZATION	MORE INFO
Motorized Pricing Examples - Surcharges - Options	Pg 6
Insulating SlumberShades	\$142 See Pages 37-38 For More Information

**Color Lux® Cellular Shades**  
**PRICING**

**Color Lux® Linen Weave, Verona Textures & Boutique Light Filtering**

**Price Group 3**  
**Ovation Cellular Slider**

Width In Inches

	24	30	36	42	48	54	60	66	72	78	84	96	108	120	132	144	156	168
36	488	527	575	618	654	698	743	781	825	871	908	984	1059	1138	1216	1295	1377	1456
42	519	568	620	669	710	758	809	854	905	952	995	1082	1164	1259	1351	1445	1536	1630
48	553	602	665	718	766	818	874	929	983	1029	1083	1184	1275	1378	1480	1582	1682	1786
54	583	645	707	767	819	877	934	999	1059	1113	1172	1281	1384	1496	1610	1722	1836	1947
60	616	681	748	814	874	937	1003	1071	1133	1195	1257	1379	1493	1615	1741	1863	1988	2114
66	651	722	795	865	929	998	1064	1144	1209	1281	1339	1480	1602	1735	1864	1997	2128	2260
72	687	761	838	916	989	1060	1132	1215	1287	1363	1428	1583	1710	1858	2006	2154	2304	2450
78	722	802	884	968	1045	1122	1198	1290	1366	1446	1516	1677	1818	1975	2130	2286	2447	2602
84	758	842	928	1022	1105	1184	1267	1361	1446	1529	1604	1777	1928	2092	2260	2426	2592	2757
90	791	880	977	1074	1158	1246	1337	1437	1524	1613	1697	1878	2033	2217	2401	2584	2768	2952
96	823	920	1023	1124	1214	1305	1408	1510	1604	1699	1785	1978	2145	2334	2523	2711	2902	3090
108	855	956	1067	1177	1268	1366	1474	1580	1681	1785	1872	2081	2255	2451	2644	2838	3032	3226

**Color Lux® Linen Weave, Verona Textures & Boutique Room Darkening**

**Price Group 4**  
**Ovation Cellular Slider**

Width In Inches

	24	30	36	42	48	54	60	66	72	78	84	96	108	120	132	144	156	168
36	635	686	748	804	851	908	966	1016	1073	1133	1181	1280	1377	1480	1581	1684	1791	1893
42	675	739	806	870	923	986	1052	1111	1177	1238	1294	1407	1514	1637	1757	1879	1997	2119
48	719	783	865	934	996	1064	1137	1208	1278	1338	1408	1540	1658	1792	1924	2057	2187	2322
54	758	839	920	998	1065	1141	1215	1299	1377	1447	1524	1666	1800	1945	2093	2239	2387	2532
60	801	886	973	1059	1137	1219	1304	1393	1473	1554	1635	1793	1941	2100	2264	2422	2585	2749
66	847	939	1034	1125	1208	1298	1384	1488	1572	1666	1741	1924	2083	2256	2424	2597	2767	2938
72	894	990	1090	1191	1286	1378	1472	1580	1674	1772	1857	2058	2223	2416	2608	2801	2996	3185
78	939	1043	1150	1259	1359	1459	1558	1677	1776	1880	1971	2181	2364	2568	2769	2972	3182	3383
84	986	1095	1207	1329	1437	1540	1648	1770	1880	1988	2086	2311	2507	2720	2938	3154	3370	3585
90	1029	1144	1271	1397	1506	1620	1739	1869	1982	2097	2207	2442	2643	2883	3122	3360	3599	3838
96	1070	1196	1330	1462	1579	1697	1831	1963	2086	2209	2321	2572	2789	3035	3280	3525	3773	4017
108	1112	1243	1388	1531	1649	1776	1917	2054	2186	2321	2434	2706	2932	3187	3438	3690	3942	4194

PRODUCT INFORMATION		
	See Page 33 for detailed information.	
DESIGN UPGRADES		
	Scotchgard Stain Protector	Add \$38 per shade
	Center Stack	Add \$88   Left or Right Stack Standard
	Split Stack*	Price by dividing the full width measurement in half. Price as two separate units and add together.
	Dual Panel**	Price as two separate units and add together.

\* Split stack sliders are available in widths up to 240". If the width exceeds 120", it will be fabricated as two separate sliders. The supplied valance will create the appearance of a single slider.

\*\* A Dual Panel Stack Slider has a center opening design with a different fabric on each side, each of which can span the full width of the window. Both panels will be of equal width unless otherwise specified.

# Color Lux® Cellular Shades

## PRICING

### Color Lux® Linen Weave, Verona Textures & Boutique Light Filtering

**Price Group 5**  
**Starburst Arches**  
**Quarter Rounds**

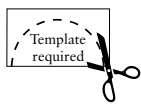

For widths wider than 58"

**Fabric Wrapped or Designer Metallic Hardware Included**

	Width In Inches								
	24	30	36	42	48	54	60	66	72
Non-Movable Starburst	286	322	363	410	486	554	622	699	784
Movable Starburst	395	444	503	565	671	749	840	937	1043
Non-Movable Quarter Rounds	363	410	464	526	595	673			
Movable Quarter Rounds	486	548	620	696	784				

### Color Lux® Linen Weave, Verona Textures & Boutique Light Filtering

**Price Group 6**  
**Starburst Arches**  
**Quarter Rounds**

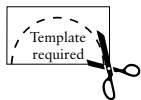

For widths wider than 58"

**Fabric Wrapped or Designer Metallic Hardware Included**

	Width In Inches								
	24	30	36	42	48	54	60	66	72
Non-Movable Starburst	396	443	496	557	656	745	833	933	1044
Movable Starburst	538	602	678	759	897	998	1116	1243	1380
Non-Movable Quarter Rounds	496	557	628	708	798	899			
Movable Quarter Rounds	656	737	830	929	1044				

**Non-Movable Starburst Product Information:**

Templates required on non-perfect non-movable Starburst Arches. See page 41 for more information.  
 Fabric wrapped rail is standard. There will be a splice in the center. A decorative rosette is supplied to cover the splice.

**Pricing Information:**

Price according to the largest radius measurement. If the height is greater than the width, take height multiplied by 2 and use that number to determine pricing.

FABRIC SURCHARGES		ADD
Scotchgard Stain Protector		\$38
PRICING INFORMATION		
Starburst Arches	Price according to the largest radius measurement. If the height is greater than the width, take height X 2 and use that number to determine pricing. Metallic rails available.	
Quarter Rounds	Price according to the largest radius measurement.	
HARDWARE UPGRADE SURCHARGES* AND ACCESSORIES		ADD
Metallic Hardware or Fabric Wrapped Rails		No Extra Charge
6 Foot Expandable Pole		\$44
12 Foot Expandable Pole		\$54

**Color Lux® Cellular Shades**  
**PRICING**

**Color Lux® Linen Weave, Verona Textures  
 & Boutique Light Filtering**

**Price Group 7**  
**Sunset Movable Arches**  
**Fabric Wrapped or Designer Metallic Hardware Included**

	Width In Inches								
	<b>24</b>	<b>30</b>	<b>36</b>	<b>42</b>	<b>48</b>	<b>54</b>	<b>60</b>	<b>66</b>	<b>72</b>
<b>Half Round</b>	364	402	425	475	505	564	597	654	713
<b>36</b>	464	506	530	565	589	630	649	682	713
<b>42</b>	488	537	558	611	631	679	700	738	771
<b>48</b>	516	565	595	647	670	709	751	790	831
<b>60</b>	563	630	660	727	758	821	854	903	951

**Sunset Product Information:**  
 Templates required on non-perfect Sunset Arches. See page 44.

**Color Lux® Linen Weave, Verona Textures  
 & Boutique Room Darkening**

**Price Group 8**  
**Sunset Movable Arches**  
**Fabric Wrapped or Designer Metallic Hardware Included**

	Width In Inches						
	<b>24</b>	<b>30</b>	<b>36</b>	<b>42</b>	<b>48</b>	<b>54</b>	<b>60</b>
<b>Half Round</b>	466	516	546	611	650	726	769
<b>36</b>	596	651	682	728	759	812	837
<b>42</b>	628	691	719	788	814	876	903
<b>48</b>	664	728	767	834	864	915	970
<b>60</b>	725	812	851	938	979	1061	1103

**Sunset Product Information:**  
 Templates required on non-perfect Sunset Arches. See pages 44.

PRODUCT INFORMATION		
	See Page 44 for detailed information.	
DESIGN UPGRADES		
	Scotchgard Stain Protector	Add \$38 per shade
	6 Foot Expandable Pole	Add \$44
	12 Foot Expandable Pole	Add \$54



**Color Lux® Cellular Shades**

**PRICING**

**Color Lux® Linen Weave, Verona Textures  
& Boutique Light Filtering**

**Price Group 9  
Trapezoids and Octagons  
Fabric Wrapped or Designer Metallic Hardware Included**

		Width In Inches						
		24	30	36	42	48	54	60
Length In Inches	36	493	521	556	594	626	658	689
	42	510	543	581	622	658	694	733
	48	525	564	608	651	689	730	773
	54	542	583	631	677	721	767	811
	60	560	605	657	705	752	807	854
	66	577	626	682	734	788	842	891
	72	594	645	705	764	821	878	937

**Color Lux® Linen Weave, Verona Textures  
& Boutique Room Darkening**

**Price Group 10  
Trapezoids and Octagons  
Fabric Wrapped or Designer Metallic Hardware Included**

		Width In Inches						
		24	30	36	42	48	54	60
Length In Inches	36	634	671	716	765	807	849	889
	42	656	699	749	802	849	895	946
	48	676	726	784	840	889	942	998
	54	698	751	814	873	931	990	1048
	60	721	780	847	910	971	1042	1103
	66	743	807	880	947	1018	1088	1152
	72	765	832	910	986	1061	1135	1211

PRODUCT INFORMATION	
	See page 46 for detailed information. Width, length and one side are required measurements for Octagon Shades. <b>Trapezoid orders must be faxed in with a diagram that includes the measurements for 4 sides.</b>
DESIGN UPGRADES	
Scotchgard Stain Protector	Add \$38 per shade

**Color Lux® Cellular Shades**  
**PRICING**

**Color Lux® Linen Weave, Verona Textures & Boutique Light Filtering**

**Price Group 11**  
**Mezzo Motorized Skylights**  
**White Rail and White Track**

		Width In Inches				
		24	30	36	42	48
Length In Inches	36	442	500	556	621	672
	42	468	531	601	664	736
	48	492	568	637	710	788
	54	520	600	679	754	851
	60	539	632	715	800	912
	66	568	661	751	841	971
	72	600	699	784	874	1024

Be sure to add the Simplicity motor surcharges and upgrades to the grid above.

**Color Lux® Linen Weave, Verona Textures & Boutique Room Darkening**

**Price Group 12**  
**Mezzo Motorized Skylights**  
**White Rail and White Track**

		Width In Inches				
		24	30	36	42	48
Length In Inches	36	568	643	716	801	867
	42	602	684	775	856	950
	48	633	732	821	916	1018
	54	669	773	876	973	1100
	60	694	815	923	1033	1179
	66	732	853	970	1087	1256
	72	773	902	1012	1129	1324

Be sure to add the Simplicity motor surcharges and upgrades to the grid above.

MOTORIZED	UPGRADES	ADD	
Simplicity Rechargeable Motorization System	Motor and Battery Wand	\$368	For More Information Page 25
	Simplicity 5 Channel Remote	\$44	
	Simplicity 6 Channel Remote/Timer	\$72	
	Simplicity 14 Channel White Remote	\$72	
	Plug-In Charger for Rechargeable Li-Ion	\$30	
Simplicity Smart Controller System	NEO Controller	\$363	For More Information Page 30
	NEO Application for Mobile Devices	FREE	

**Color Lux® Cellular Shades**

**PRICING**

**Color Lux® Linen Weave, Verona Textures  
& Boutique Light Filtering**

**Price Group 13**

**Non-Movable Door Decors**

**Fabric Wrapped or Designer Metallic Hardware Included**

		Width In Inches				
		<b>12</b>	<b>18</b>	<b>24</b>	<b>30</b>	<b>36</b>
Length In Inches	<b>36</b>	119	126	132	145	162
	<b>42</b>	126	133	139	156	171
	<b>48</b>	132	139	146	165	185
	<b>54</b>	139	147	154	173	197
	<b>60</b>	147	155	163	184	207
	<b>66</b>	153	162	170	195	221
	<b>72</b>	160	169	177	202	231
	<b>78</b>	167	176	185	212	241
	<b>84</b>	172	182	191	222	252
	<b>90</b>	180	190	199	230	263
	<b>96</b>	184	194	204	238	274

**Color Lux® Linen Weave, Verona Textures  
& Boutique Room Darkening**

**Price Group 14**

**Non-Movable Door Decor**

**Fabric Wrapped or Designer Metallic Hardware Included**

		Width In Inches				
		<b>12</b>	<b>18</b>	<b>24</b>	<b>30</b>	<b>36</b>
Length In Inches	<b>36</b>	148	157	164	181	203
	<b>42</b>	157	165	174	196	215
	<b>48</b>	165	174	183	207	233
	<b>54</b>	174	184	193	218	249
	<b>60</b>	185	195	205	232	262
	<b>66</b>	193	204	214	246	280
	<b>72</b>	201	212	223	255	293
	<b>78</b>	210	222	233	268	306
	<b>84</b>	217	230	241	281	320
	<b>90</b>	227	239	252	292	335
	<b>96</b>	233	246	258	302	349

PRODUCT INFORMATION		
See Page 51 for detailed information.		
DESIGN UPGRADES		
Scotchgard Stain Protector	Add \$38 per shade	
6 Foot Expandable Pole	Add \$44	
12 Foot Expandable Pole	Add \$54	

**Color Lux® Cellular Shades**  
**PRICING**

**Color Lux® Linen Weave, Verona Textures  
 & Boutique Light Filtering**

**Price Group 15**  
**Movable Door Decors**  
**Fabric Wrapped or Designer Metallic Hardware Included**

		Width In Inches				
		12	18	24	30	36
Length In Inches	36	215	227	238	261	292
	42	227	240	251	281	308
	48	238	251	263	297	333
	54	251	265	278	312	355
	60	265	279	294	332	373
	66	276	292	306	351	398
	72	288	305	319	364	416
	78	301	317	333	382	434
	84	310	328	344	400	454
	90	324	342	359	414	474
96	332	350	368	429	494	

**Color Lux® Linen Weave, Verona Textures  
 & Boutique Room Darkening**

**Price Group 16**  
**Movable Door Decor**  
**Fabric Wrapped or Designer Metallic Hardware Included**

		Width In Inches				
		12	18	24	30	36
Length In Inches	36	267	283	296	327	367
	42	283	297	313	353	388
	48	297	314	329	374	420
	54	314	332	348	392	449
	60	333	351	369	418	472
	66	348	368	385	444	505
	72	362	382	402	460	528
	78	378	400	420	484	551
	84	391	414	434	507	577
	90	409	431	453	526	603
96	420	443	465	544	629	

PRODUCT INFORMATION		
	See Page 51 for detailed information.	
DESIGN UPGRADES		
	Top Down-Bottom Up	Add \$175
	Scotchgard Stain Protector	Add \$38 per shade
	6 Foot Expandable Pole	Add \$44
	12 Foot Expandable Pole	Add \$54

# Color Lux® Cellular Shades

## STANDARD CORD LOCK SHADES HARDWARE SYSTEM



**Cord Lock Rail**

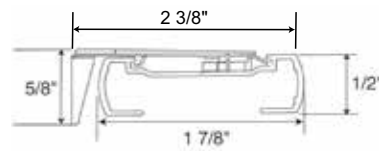

**Cord Lock Rail**

- Depth of rail: 1 7/8"
- Depth of rail and bracket: 2 3/8"
- Height: 1/2"
- Height of bracket: 5/8"

<b>Hardware Features</b>	
Fabric Wrapped	Fabric used is same fabric as the shade. Back of rail is white to outside. Color coordinated end caps with white cord and tassel
Designer Metallic	<ul style="list-style-type: none"> <li>• Oil Rubbed Bronze head and bottom rails with bronze colored tassel, end caps and white cord.</li> <li>• Brushed Nickel head and bottom rails and end caps with coordinating tassel and white cord.</li> </ul>
<b>Mounting Dimensions</b>	
	<b>Cord Lock Rail</b>
Minimum Shallow Mount	3/4"
Minimum Flush Inside Mount	2 3/8"
Minimum Outside Mount	3/4"
Minimum Side Mount	1 3/8"
<b>Recommended Side Mounting Method</b>	<ul style="list-style-type: none"> <li>• See figure B for recommended mounting method for side mount shades</li> <li>• Width limit for side mount brackets is 48"</li> </ul>
<b>Finished Dimensions</b>	
<b>Inside and Side Mount</b>	
	<ul style="list-style-type: none"> <li>• Fabric will measure ordered width less: 3/8"</li> <li>• Head rail* will measure ordered width less: 3/16"</li> </ul>
<b>Outside Mount</b>	
	<ul style="list-style-type: none"> <li>• Fabric will measure ordered width</li> <li>• Head rail* will measure ordered width plus: 3/16"</li> </ul>
<b>Exact (End Cap to End Cap) Mount</b>	
	<ul style="list-style-type: none"> <li>• Fabric will measure ordered width less: 3/16"</li> <li>• Head rail* will measure ordered width</li> </ul>
* Head rail measurements include endcaps. Width and length measurements may vary +/- 1/8"	



# Color Lux® Cellular Shades

## STANDARD CORD LOCK SHADES HARDWARE SYSTEM

### Applications

- Standard Rectangular
- Day-Night
- Trapezoids and Octagons
- Top Down - Bottom Up
- Two-On-One Head Rail

### Highlights Cornice Valance

Add a designer finishing touch to a cellular shade with a Highlights Cornice Valance. See page 55 for details.

### Things to Consider

- If child safety is a concern, consider cordless options: Cordless Ultra, Cordless Lift & Lock or Motorization.
- Larger shades can be difficult to operate. Consider Cord Loop, Cordless Ultra or Motorization hardware.
- If privacy is an issue, consider Top Down-Bottom Up options.

### Recommended Mounting Method for Side Mount Shades

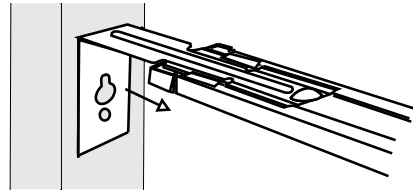

Figure B

### EZ Level on Cellular Shades

EZ Level makes quick work of leveling without cords to cut or tuck into a rail. See page 55 for details.

### Day-Night Shades

See pages 53-54 for more information.

### Specialties (Trapezoids and Octagons)

See pages 46-47 for more information.



# Color Lux® Cellular Shades

## CORD LOOP HARDWARE SYSTEM

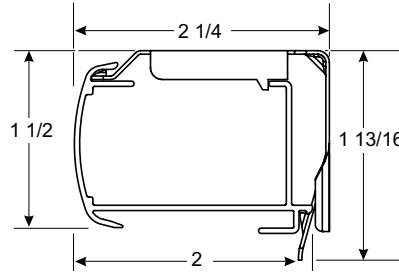

### Cord Loop Rail Dimensions

- Depth of rail: 2"
- Depth of rail and bracket: 2 1/4"
- Height of rail: 1 1/2"
- Height of bracket: 1 13/16"

<b>Hardware Features</b>	
Fabric Wrapped	Fabric used is same fabric as the shade. Back of rail is white to outside. Clutch cover will be white. Frosted clear with fabric insert end caps with white cord.
Designer Metallic	<ul style="list-style-type: none"> <li>• Oil Rubbed Bronze head and bottom rails with bronze colored end caps and cord.</li> <li>• Brushed Nickel head and bottom rails, end caps with white cord.</li> </ul>
<b>Mounting Dimensions</b>	
<b>Cord Loop Hardware System</b>	
Minimum Shallow Mount	1/2"
Minimum Flush Inside Mount	2 1/4"
Minimum Outside Mount	7/8"
Minimum Side Mount	1 1/4"
<b>Recommended Side Mounting Method</b>	<ul style="list-style-type: none"> <li>• See figure A for recommended mounting method for side mount shades</li> <li>• Width limit for side mount brackets is 48"</li> </ul>
<b>Finished Dimensions</b>	
<b>Inside Mount</b>	
	<ul style="list-style-type: none"> <li>• Fabric will measure ordered width less: 3/8"</li> <li>• Head rail* will measure ordered width less: 3/16"</li> </ul>
<b>Outside Mount</b>	
	<ul style="list-style-type: none"> <li>• Fabric will measure ordered width</li> <li>• Head rail* will measure ordered width plus: 3/16"</li> </ul>
<b>Side Mount</b>	
	<ul style="list-style-type: none"> <li>• Fabric will measure ordered width less: 7/8"</li> <li>• Head rail* will measure ordered width less: 1 1/16"</li> </ul>
<b>Exact (End Cap to End Cap) Mount</b>	
	<ul style="list-style-type: none"> <li>• Fabric will measure ordered width less: 3/16"</li> <li>• Head rail* will measure ordered width</li> </ul>
* Head rail measurements include endcaps. Width and length measurements may vary +/- 1/8"	

# Color Lux® Cellular Shades

## CORD LOOP HARDWARE SYSTEM

### Applications

- Standard Rectangular
- Two-On-One Head Rail
- Top Down - Bottom Up

### Cord Loop Hardware System Features

Cord loops are available 2' to 15' lengths in 1' intervals. Please specify length when ordering. Standard loop sizes are as follows:

Shade Length	Standard Loop
Up to and including 26 <sup>7</sup> / <sub>8</sub> "	1' (12")
27" to 39 <sup>7</sup> / <sub>8</sub> "	2' (24")
40" to 59 <sup>7</sup> / <sub>8</sub> "	3' (36")
60" to 83 <sup>7</sup> / <sub>8</sub> "	4' (48")
84" to 107 <sup>7</sup> / <sub>8</sub> "	5' (60")
108" and greater	6' (72")

### Recommended Mounting Method for Side Mounting Shades

Width limit for side mount brackets is 48".

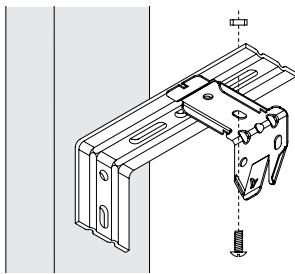

Cord Loop Hardware  
Cordless Ultra Hardware  
Cordless Ultra Top Down -  
Bottom Up Hardware

Figure A

Refer to the installation instructions on [Comfortex.com/comfortex-dealers](http://Comfortex.com/comfortex-dealers) or the OnDemand Mobile Library for further details on side mounting shades.

### Ordering Information for Cord Loop Hardware Shades

#### Standard Rectangular

- Specify LB or OB mount, rail color and left or right lift cord.
- Specify cord loop length when ordering.

#### Top Down - Bottom Up

- Specify LB or OB mount and rail color. Middle rail will match the top and bottom rails.
- Specify cord loop length when ordering.
- Controls are the right cord loop operates the middle rail and left cord loop operates the bottom. Reverse controls are not available.

#### Two-On-One Head Rail

- Two-On-One Head Rail Shades operate as two separate shades on one head rail.
- Specify LB or OB mount and rail color.
- Specify panel sizes.
- Specify cord loop length when ordering.
- <sup>3</sup>/<sub>8</sub>" Space between panels.
- Fabric wrapped Two-On-One Shades will have a seam in the center of the rail due to the wide width.

### Highlights Cornice Valance

Add a designer finishing touch to a cellular shade with a Highlights Cornice Valance. See page 55 for details.

### EZ Level on Comfortex Cellular Shades

EZ Level makes quick work of leveling without cords to cut or tuck into a rail. No special tools needed – just use a nickel, quarter or penny to adjust plug on the bottom rail.

EZ Level is standard on all Cellular and Pleated Shades with the following hardware systems:  
Standard Cord Lock, Cordless Ultra, Cord Loop Simplicity Motorized Systems

EZ Level is not available with Cordless Lift & Lock.

#### How does EZ Level work?

- Slightly raise the bottom rail you want to level.
- Insert a coin or flat head screwdriver into the adjustment screw and turn it.
- Turn the adjustment screw clockwise or counter clockwise to make slight adjustments up or down. One quarter turn of the adjustment screw will move the bottom rail up or down <sup>1</sup>/<sub>4</sub>".
- Lower the rail to check the level and make further adjustments if necessary.



**Color Lux® Cellular Shades**  
**CORDLESS ULTRA HARDWARE SYSTEM**

COLORLUX® CELLULAR SHADES

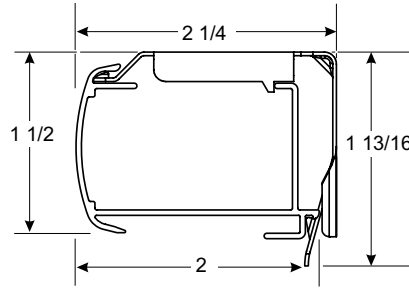

**Cord Loop Rail Dimensions**

- Depth of rail: 2"
- Depth of rail and bracket: 2 1/4"
- Height of rail: 1 1/2"
- Height of bracket: 1 13/16"

**Hardware Features**

Fabric Wrapped	Fabric used is same fabric as the shade. Back of rail is white to outside. Frosted clear with fabric insert end caps with white cord.
Designer Metallic	<ul style="list-style-type: none"> <li>• Oil Rubbed Bronze head and bottom rails with bronze colored end caps and cord.</li> <li>• Brushed Nickel head and bottom rails, end caps.</li> </ul>

**Mounting Dimensions**

**Cord Loop Hardware System**

Minimum Shallow Mount	1/2"
Minimum Flush Inside Mount	2 1/4"
Minimum Outside Mount	7/8"
Minimum Side Mount	1 1/4"
<b>Recommended Side Mounting Method</b>	<ul style="list-style-type: none"> <li>• See figure A, page 20 for recommended mounting method for side mount shades</li> <li>• Width limit for side mount brackets is 48"</li> </ul>

**Finished Dimensions**

**Inside Mount**

- Fabric will measure ordered width less: 3/8"
- Head rail\* will measure ordered width less: 3/16"

**Outside Mount**

- Fabric will measure ordered width
- Head rail\* will measure ordered width plus: 3/16"

**Side Mount**

- Fabric will measure ordered width less: 7/8"
- Head rail\* will measure ordered width less: 1 1/16"

**Exact (End Cap to End Cap) Mount**

- Fabric will measure ordered width less: 3/16"
- Head rail\* will measure ordered width

\* Head rail measurements include endcaps. Width and length measurements may vary +/- 1/8"

# Color Lux® Cellular Shades

## CORDLESS ULTRA HARDWARE SYSTEM

### Applications

- Standard Rectangular
- Top Down - Bottom Up
- Two-On-One Head Rail

### Things to Consider

- Is the top of your window out of reach? You can order an extension pole to reach but it can still be tricky. You may want to consider Cord Loop or Motorized hardware.
- For shades mounted on doors, you may want to order hold down brackets.
- If privacy is an issue, consider Top Down-Bottom Up options.

### Ordering Information for Cordless Ultra Hardware Shades

#### Standard Rectangular

- Specify LB or OB mount and rail color.

#### Top Down - Bottom Up

- Specify LB or OB mount and rail color. Middle rail will match the head and bottom rails.

### Accessories

- 6' Expandable Pole:
- 12' Expandable Pole:

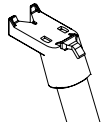

Specially designed pole end fits into the handle on the bottom rail and allows for easy operation.

### Cordless Ultra and Cordless Ultra Top Down - Bottom Up Hardware Features

- Children and pets have safer surroundings in homes that have window shades without operating cords, reducing the risk of strangulation.
- Cordless Ultra and Cordless Ultra Top Down - Bottom Up Shades can be raised or lowered with a gentle push or pull on the rail handle.
- Cordless Ultra Top Down - Bottom Up Shades feature two moving rails.
- Order an operating pole for out of reach applications.



Fabric Wrapped Head Rail and Designer Metallic Head Rails.

### Cordless Ultra Shade Operation

Cordless shades should be operated from the handle located in the center of the bottom rail. Using the handle will aid in smooth and easy shade operation. Two handles are supplied on wider width shades.

To lower the shade, pull down on the handle which is secured to the bottom rail and guide the rail to desired position (Figure A). For out of reach applications, an optional extension pole should be used.

To raise the shade, push the bottom rail up using the handle on the bottom rail and guide the rail to the desired position. The shade will hold any position when the bottom rail is released. Raise the shade slowly and steadily to allow the shade to stack evenly (Figure B).

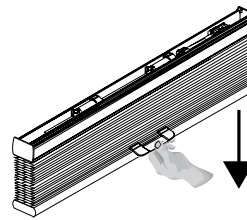

Figure A

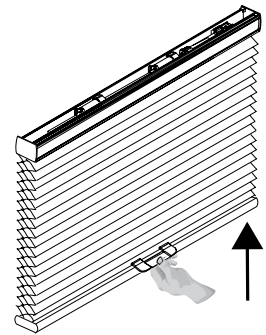

Figure B



Clear Cordless Handle

### Recommended Mounting Method for Side Mounting Shades

See Page 20.

### Highlights Cornice Valance

Add a designer finishing touch to a cellular shade with a Highlights Cornice Valance. See page 55 for details.

### EZ Level on Cellular Shades

EZ Level makes quick work of leveling without cords to cut or tuck into a rail. See page 55 for details.

# Color Lux® Cellular Shades

## CORDLESS LIFT & LOCK HARDWARE SYSTEM

COLORLUX® CELLULAR SHADES



**Cordless Lift & Lock Head Rail**

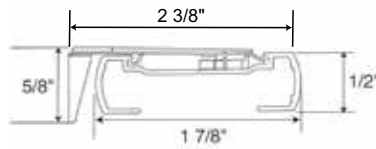

**Cordless Lift & Lock Rail**

- Depth of rail: 1 7/8"
- Depth of rail and bracket: 2 3/8"
- Height: 1/2"
- Height of bracket: 5/8"

<b>Hardware Features</b>	
Hardware	<ul style="list-style-type: none"> <li>• Fabric wrapped head, middle and bottom rails. Shades will have a coordinated or white push button/handle and end caps on the middle/bottom rail. Refer to coordination chart in the Dealer Resource Center in the Fabrication section online.</li> <li>• Fabric used to cover the rails is the same fabric as the shade. The back of the rail will be white to the outside.</li> </ul>
<b>Upgrades</b>	
Designer Metallic Upgrade	<ul style="list-style-type: none"> <li>• Smooth faced Designer Oil Rubbed Bronze Metallic head, middle and bottom rail and end caps.</li> <li>• Oil Rubbed Bronze push button/handle on the middle and bottom rails.</li> </ul>
<b>Mounting Dimensions</b>	
<b>Lift &amp; Lock Head Rail</b>	
Minimum Shallow Mount	3/4"
Minimum Flush Inside Mount	2 1/2"
Minimum Outside Mount	3/4"
Minimum Side Mount	1 3/8"
<b>Recommended Side Mounting Method</b>	<ul style="list-style-type: none"> <li>• See figure A (pg 20) for recommended mounting method for side mount shades</li> <li>• Width limit for side mount brackets is 48"</li> </ul>
<b>Finished Dimensions</b>	
<b>Inside and Side Mount</b>	
	<ul style="list-style-type: none"> <li>• Fabric will measure ordered width less: 3/8"</li> <li>• Head rail* will measure ordered width less: 3/16"</li> </ul>
<b>Outside Mount</b>	
	<ul style="list-style-type: none"> <li>• Fabric will measure ordered width</li> <li>• Head rail* will measure ordered width plus: 3/16"</li> </ul>
<b>Exact (End Cap to End Cap) Mount</b>	
	<ul style="list-style-type: none"> <li>• Fabric will measure ordered width less: 3/16"</li> <li>• Head rail* will measure ordered width</li> </ul>
* Head rail measurements include endcaps. Width and length measurements may vary +/- 1/8"	



# Color Lux® Cellular Shades

## CORDLESS LIFT & LOCK HARDWARE SYSTEM

### Cordless Lift & Lock Shades Hardware System Bottom Rail Dimensions

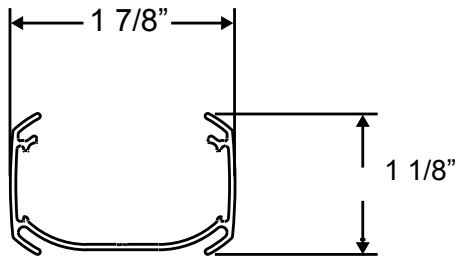

- Depth of rail: 1 7/8"
- Height of rail: 1 1/8"

### Applications

- Standard Rectangular
- Top Down-Bottom Up

### Important Operating Note on Cordless Lift & Lock Shades

- To operate a Cordless Lift & Lock Shade, the middle or bottom rails must be accessible. An extension pole is not available for Cordless Lift & Lock Shades.
- If the bottom or middle rail is not accessible, you may want to consider Cord Loop, Cordless Ultra or Motorized hardware. An extension pole is not available for Cordless Lift & Lock Shades.
- For shades mounted on doors, you may want to order hold down brackets.

### Cordless Lift & Lock Hardware Features

- Children and pets have safer surroundings in homes that have window shades without operating cords, reducing the risk of strangulation.
- Cordless Lift & Lock Shades can be raised or lowered by pressing the button located on the bottom rail and guiding the rail into the desired location.

### Leveling the Bottom Rails

Each Cordless Lift & Lock Shade includes a skew adjustment leveling tool hidden in the bottom rail of each shade.

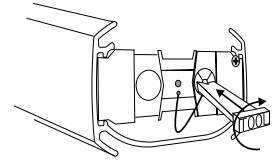

To level the bottom rail, remove the bottom rail end cap to access the tool which allows you to adjust the placement of the bottom rail. Adjustment instructions are supplied with each shade.

### Ordering Information for Cordless Lift & Lock Shades

#### Standard Rectangular

- Specify IB or OB mount and rail color.

### Cordless Lift & Lock Shade Operation

Cordless Lift & Lock Shades are operated using the push button handle located in the center of the bottom rail.

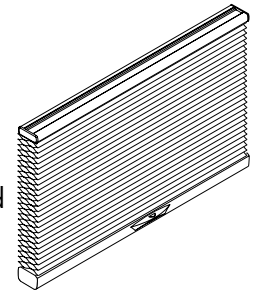

To raise or lower the shade; press the button on the shade handle, and guide the rail to desired position. Release the button to lock the shade into place.

The shade will hold any position when the button is released. Raise the shade slowly and steadily to allow the shade to stack evenly.

### Recommended Mounting Method for Side Mounting Shades

See Page 20.

### Highlights Cornice Valance

Add a designer finishing touch to a cellular shade with a Highlights Cornice Valance. See page 55 for details.



Fabric Wrapped Head Rail with White End Caps



Fabric Wrapped Bottom Rail with White push button/handle



Oil Rubbed Bronze Head Rail and End Caps



Oil Rubbed Bottom Rail and push button/handle



# Color Lux® Cellular Shades

## RECHARGEABLE SIMPLICITY MOTORIZED HARDWARE SYSTEM

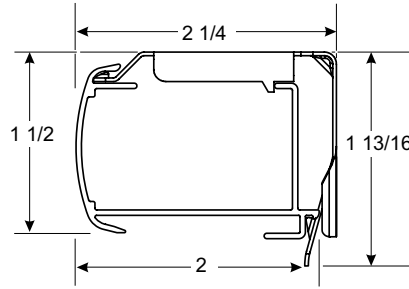

### Simplicity Rechargeable Rail Dimensions

- Depth of rail: 2"
- Depth of rail and bracket: 2 1/4"
- Height of rail: 1 1/2"
- Height of bracket: 1 13/16"

### Hardware Features

Standard Hardware	<ul style="list-style-type: none"> <li>• Fabric Wrapped head and bottom rails. Head rail and Bottom rails will have frosted end caps with fabric inserts.</li> <li>• Fabric used to cover the rails is the same fabric as the shade. The back of the rail will be white to the outside.</li> </ul>
Simplicity Remote	Upper and lower limit stops pre-programmed, Intermediate stop "favorites" position can be set on site.
<b>Upgrades</b>	
Designer Metallic Upgrade	<ul style="list-style-type: none"> <li>• Smooth faced Designer Oil Rubbed Bronze head, middle, bottom rails and end caps</li> <li>• Smooth faced Designer Brushed Nickel head, middle, bottom rails and end caps</li> </ul>

### Mounting Dimensions

### Simplicity Rechargeable Motorization Hardware System

Minimum Shallow Mount	1/2"
Minimum Flush Inside Mount	2 1/4"
Minimum Outside Mount	7/8"
Minimum Side Mount	1 1/4"
<b>Recommended Side Mounting Method</b>	<ul style="list-style-type: none"> <li>• See page 20 for recommended mounting method for side mount shades</li> <li>• Width limit for side mount brackets is 48"</li> </ul>

### Finished Dimensions

#### Inside Mount

- Fabric will measure ordered width less: 3/8"
- Head rail\* will measure ordered width less: 3/16"

#### Outside Mount

- Fabric will measure ordered width
- Head rail\* will measure ordered width plus: 3/16"

#### Side Mount

- Fabric will measure ordered width less: 7/8"
- Head rail\* will measure ordered width less: 1 1/16"

#### Exact (End Cap to End Cap) Mount

- Fabric will measure ordered width less: 3/16"
- Head rail\* will measure ordered width

\* Head rail measurements include endcaps. Width and length measurements may vary +/- 1/8"

# Color Lux® Cellular Shades

## RECHARGEABLE SIMPLICITY MOTORIZED HARDWARE SYSTEM

### Rechargeable Simplicity Motors

The Simplicity Motor program features a battery powered motor utilizing a rechargeable battery hidden inside the shade head rail. Simplicity motors are compact and use a radio frequency remote to raise or lower the shades.

Rechargeable Motorized Lift Systems are not offered on sizes within the shaded area on the Standard Rectangular price grids.

### Applications

- Standard Rectangular

### Please Note

- Motorized shades less than 24" in width are limited to a maximum of 60" in length.

### EZ Level

Learn about the EZ Level feature on page 55.

### Rechargeable Simplicity Motorization Surcharges

The Rechargeable Simplicity Motorized Lift System surcharge includes a rechargeable battery. Remotes are needed to operate the shades. Refer to pricing pages.

### Important Simplicity Motorized Shade Operating and Installation Information

- Simplicity Motorized Shades installed into windows with metal casings may have a reduced radio frequency range, or may not operate at all, depending on the application.
- Do not let the antenna on the motor touch any metal objects. This may interfere with signals from the remote control.

SIMPLICITY RECHARGEABLE BATTERY WAND PRICING EXAMPLE:	
Linen Weave	
Light Filtering 42" x 60" Shade:	\$407.00
Simplicity Rechargeable Surcharge:	\$368.00
Charger for Rechargeable :	\$30.00
Simplicity Remote Control:	\$44.00
<b>Total List Price:</b>	<b>\$849.00</b>

### Simplicity Rechargeable Battery

The rechargeable battery is concealed in the head rail of the shade. A charger is required for the rechargeable battery. The rechargeable battery comes fully charged from the factory.

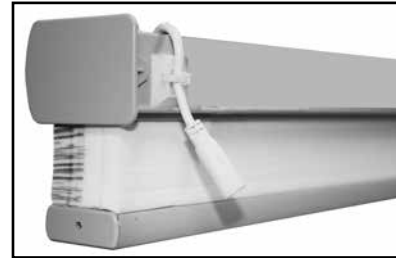

Charging Port on Back of Head rail.

### Retrofit Existing Standard Simplicity Motorized Shades with Rechargeable Batteries

Cellular shades made with Standard Simplicity Motorization can be retrofitted with the Rechargeable Simplicity Motorization Battery Wand. The Rechargeable battery wand is 22" long, comes with 10 NiMH batteries, and is white in color. Battery wands are charged at the factory.

To retrofit the rechargeable battery wand to an existing shade with a cassette head rail, you must have at least 24" between bracket centerlines to fit the battery wand. Otherwise, the wand must be placed elsewhere along the window. Wall mounting clips are provided with the wand.

### Retrofit Ordering Requirements:

- Rechargeable battery wand with clips (one per shade)
- Rechargeable battery charger (one or more per order, or as needed)
- Charge port mounting base (optional)

Please contact customer service for more information.



Battery Wand for Rechargeable Simplicity Retrofit



Rechargeable Battery Wand Concealed in Head rail. (Minimum width of 30" required) otherwise battery wand must be mounted externally.

# Color Lux® Cellular Shades

## RECHARGEABLE SIMPLICITY MOTORIZED HARDWARE SYSTEM

### Simplicity Rechargeable Battery Life

Rechargeable batteries are included with the motor.

The average battery charge will last 6-12 months based on an average sized shade raised and lowered once per day. The life of the battery charge will vary based on the type of window covering selected, the size and weight of the window covering and the number of times the shade is operated on a daily basis.

The battery can be recharged up to 500 times. It takes approximately 5 hours to recharge the motor when fully depleted.

### Ordering Information for Rechargeable Motorized Cellular Shades

#### Simplicity Motor Option

- Specify IB or OB mount and rail color.
- Specify remote and other accessories if needed.
- Specify one or more battery chargers.

#### Please Note:

- Not all motors run at the same rate of speed.
- Simplicity motors have a "Favorites" or "MY" position setting. If the homeowner wants to set several shades at the same intermediate position, follow instructions provided with installation manual.
- Simplicity Rechargeable Motorized Cellular Shades are programmed at the factory with the "up and down" limits. The shades are **UNLINKED** from the remote so they are not able to operate during shipping. Each shade should be installed **before** linking it to the remote.
- **REMEMBER: Order at least one charger if ordering rechargeable motors.**

### Simplicity Motorized Shade Warranty

Please see page 136 for complete Comfortex warranty information.

### Battery Charger

8.4 Volt charger requires a standard power outlet to recharge the battery wand. Must specify charger when ordering a Simplicity Rechargeable Wand Shade. The charger plugs into the charger port. The charger is black and comes with a 156" (13') wire. The dimensions are 1" wide x 2½" length x 1¾" deep.



### Simplicity Motor Hand Held Remotes 5 Channel Remote

The **5 Channel (5C) remote** can operate up to five shades individually or 5 groups. Simplicity Rechargeable Motorized Cellular Shades are programmed at the factory with the "up and down" limits. The shades are **UNLINKED** from the remote so they are not able to operate during shipping. Each shade should be installed **after** linking it to the remote.



Simplicity 5C remotes and holders are white or black in color. The remote comes with a holder which can be mounted to a wall for easy storage. The range of the remote is approximately 80 feet.

### 6 Channel Timer Remote

The **6 Channel (6C) timer remote** combines the functionality of a six channel hand-held control with the convenience of a programmable timer.

- The 6C timer remote allows for 18 different scheduled actions.
- Manual function disables the timer and the remote then operates as a held remote.



Simplicity 6C remotes and holders are white in color. The remote comes with a holder which can be mounted to a wall for easy storage. The range of the remote is approximately 80 feet.

Simplicity Rechargeable Motorized Cellular Shades are programmed at the factory with the "up and down" limits. The shades are **UNLINKED** from the remote so they are not able to operate during shipping. Each shade should be installed **after** linking it to the remote.

A **14 Channel (14C) remote** is also available. This remote is required for TDBU motorization but can be utilized on all Simplicity motorized shades. See page 29 for more information.

### Simplicity Motor Hand Held Remotes Operation

Press the up or down button on the remote to raise or lower the shade to your desired position.

To reprogram channel assignments, please refer to the installation instructions and/or view the video at: [comfortex.com/comfortex-dealers](http://comfortex.com/comfortex-dealers).

The Simplicity remotes utilize one 3V battery. Batteries are included. Comfortex will warranty batteries for up to 3 months from date of purchase. Batteries are not covered by the warranty.

**Color Lux® Cellular Shades**

**MOTORIZED TOP DOWN-BOTTOM UP HARDWARE SYSTEM**

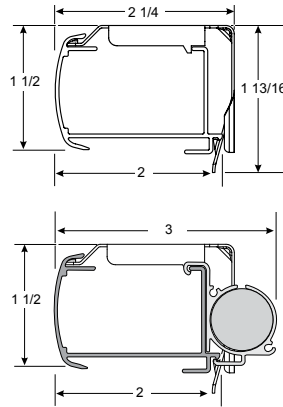

**Simplicity Motorized Rail Dimensions**

- Depth of rail: 2"
- Depth of rail and bracket: 2 1/4"
- Height of rail: 1 1/2"
- Height of bracket: 1 13/16"

**Simplicity Motorized Rail with External Battery Dimensions**

- Depth of rail: 2"
- Depth of rail, bracket & battery: 3"
- Height of rail: 1 1/2"
- Height of bracket: 1 13/16"

<b>Hardware Features</b>	
Standard Hardware	<ul style="list-style-type: none"> <li>• Fabric Wrapped head, middle and bottom rails. Head rail and Bottom rails will have frosted end caps with fabric inserts.</li> <li>• Fabric used to cover the rails is the same fabric as the shade. The back of the rail will be white to the outside.</li> </ul>
TDBU 14 Channel Remote	Upper and lower limit stops pre-programmed.
<b>Upgrades</b>	
Designer Metallic Upgrade	<ul style="list-style-type: none"> <li>• Smooth faced Designer Oil Rubbed Bronze head, middle, bottom rails and end caps</li> <li>• Smooth faced Designer Brushed Nickel head, middle, bottom rails and end caps</li> </ul>

<b>Mounting Dimensions</b>	<b>Simplicity Motorized Hardware System</b>
Minimum Shallow Mount	1/2"
Minimum Flush Inside Mount	2 1/4"
Minimum Outside Mount	7/8"
Minimum Side Mount	1 1/4"
<b>Recommended Side Mounting Method</b>	<ul style="list-style-type: none"> <li>• See page 20 for recommended mounting method for side mount shades</li> <li>• Width limit for side mount brackets is 48"</li> </ul>

**Finished Dimensions**

<b>Inside Mount</b>	
	<ul style="list-style-type: none"> <li>• Fabric will measure ordered width less: 3/8"</li> <li>• Head rail* will measure ordered width less: 3/16"</li> </ul>
<b>Outside Mount</b>	
	<ul style="list-style-type: none"> <li>• Fabric will measure ordered width</li> <li>• Head rail* will measure ordered width plus: 3/16"</li> </ul>
<b>Side Mount</b>	
	<ul style="list-style-type: none"> <li>• Fabric will measure ordered width less: 7/8"</li> <li>• Head rail* will measure ordered width less: 1 1/16"</li> </ul>
<b>Exact (End Cap to End Cap) Mount</b>	
	<ul style="list-style-type: none"> <li>• Fabric will measure ordered width less: 3/16"</li> <li>• Head rail* will measure ordered width</li> </ul>

\* Head rail measurements include endcaps. Width and length measurements may vary +/- 1/8"

# Color Lux® Cellular Shades

## MOTORIZED TOP DOWN-BOTTOM UP HARDWARE SYSTEM

### Rechargeable Simplicity Motors

The Simplicity Motor program features a battery powered motor utilizing a rechargeable battery hidden inside the shade head rail. If shades are less than 36" in width, an external snap-on battery pack is necessary. *(See picture to right)*

#### Applications

- Rectangular

#### Please Note

- Motorized shades less than 24" in width are limited to a maximum of 60" in length.

#### EZ Level

Learn about the EZ Level feature on page 55.

### Rechargeable Simplicity Motorization Surcharges

The Rechargeable Simplicity Motorized Lift System surcharge includes a rechargeable battery. Remotes are needed to operate the shades. Refer to pricing pages.

### Ordering Information for Top Down-Bottom Up Motorized Cellular Shades

#### Simplicity Motor Option

- Specify IB or OB mount and rail color.
- 14 Channel TDBU Remote is required.
- Specify one or more battery chargers.

#### Please Note:

- Shades that are 24"-36" in width will have an external battery.
- Shades with an external battery and OB mounted will need spacer blocks.
- Simplicity Rechargeable Motorized Cellular Shades are programmed at the factory with the "up and down" limits set on both moving rails.
- **REMEMBER: Order at least one charger if ordering rechargeable motors.**

### Top Down-Bottom Up Simplicity Motor Hand Held 14 Channel Remote

The TDBU remote has 14-channels. Each channel has a setting to operate the middle rail and a setting to operate the bottom rail. The TDBU remote is required for TDBU motors. The **14 Channel TDBU remote** can operate up to fourteen shades individually or 14 groups. Simplicity Rechargeable Motorized Cellular Shades are programmed at the factory with the "up and down" limits. The shades are **UNLINKED** from the remote so they are not able to operate during shipping. Each shade should be installed **after** linking it to the remote.



Simplicity TDBU remotes and holders are white in color. The remote comes with a holder which can be mounted to a wall for easy storage. The range of the remote is approximately 80 feet.

### Simplicity Rechargeable Battery

The rechargeable battery is concealed in the head rail of the shade. A charger is required for the rechargeable battery. The rechargeable battery comes fully charged from the factory.

Rechargeable Battery Pack is concealed in the head rail. Minimum width of 36" is required otherwise battery must be mounted externally.

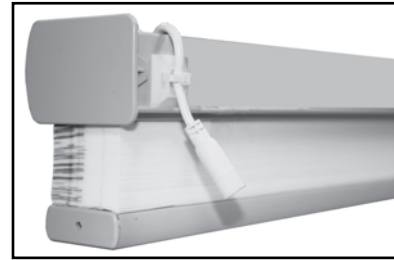

Charging Port on Back of Head rail.

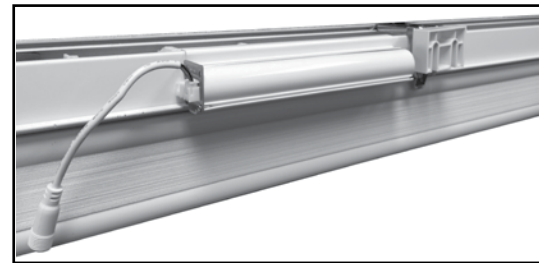

Snap-On external battery for shades under 36" in width. Spacer block also shown, required for outside mount.

### Battery Charger

8.4 Volt charger requires a standard power outlet to recharge the battery wand. Must specify charger when ordering a Simplicity Rechargeable Wand Shade. The charger plugs into the charger port. The charger is black and comes with a 156" (13') wire. The dimensions are 1" wide x 2½" length x 1¾" deep.



### MOTORIZED TOP DOWN-BOTTOM UP PRICING EXAMPLE:

Linen Weave	
Light Filtering 42" x 60" Shade:	\$407.00
Simplicity Rechargeable Surcharge:	\$589.00
Charger for Rechargeable:	\$30.00
TDBU Remote Control:	\$72.00
<b>Total List Price:</b>	<b>\$1098.00</b>



**Color Lux® Cellular Shades**  
**SIMPLICITY SMART CONTROLLER**

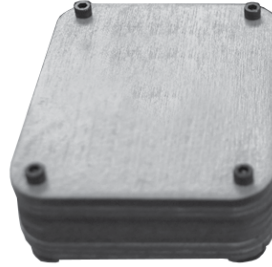

**Simplicity Smart Controller Dimensions**

- Width of controller: 2 3/8"
- Length of controller: 2 15/16"
- Height of controller: 1 1/8"

**Simplicity Smart Controller**

- Works with Apple and Android devices
- FREE Downloadable Application
- Compatible with previously installed Simplicity Remote Control Shades
- Powered by NEO Smart Blinds App
- Compatible with Amazon Alexa and Google Assistant systems

**Simplicity Smart Controller**

The Simplicity Smart Controller is a small device that you install in your home that allows you to set automatic opening and closing times for all Simplicity motorized shades as well as the ability to control your motorized shades from a phone, tablet or PC from anywhere in world.

The Simplicity Smart Controller will work with any Comfortex remote motorized shade with Simplicity remote control motors purchased after 2012.

The Simplicity Smart Controller plugs into a standard electrical outlet and connects to WiFi and sends signals to your shades using the same radio frequencies as a normal remote control.

**How Does The NEO Smart Blinds App Work?**

The app uses WiFi or cellular data to send commands over the internet to the Simplicity Smart Controller.

**Do I Need Any Other Equipment?**

Yes, The location where your shades are installed must have WiFi in order for the Simplicity Smart Controller to work. Additionally, you must have a smartphone or tablet running Android or iOS (eg. iPhone, iPad, Samsung Galaxy S7) and have the NEO Smart Blinds app. installed.

**Why Would I Want A Simplicity Smart Controller?**

There are two main ways the Simplicity Smart Controller adds additional value to your motorized shades. First, once all of your shades have been added, you can use your smartphone as a single remote for all of your shades that will work anywhere you are regardless of distance from the shade. Secondly, the device allows you to set schedules so your motorized shades automatically open and close without needing to do anything on a day to day basis.

**Do I Need To Buy More Than 1 Controller?**

The normal use for the Simplicity Smart Controller is to plug it in out of the way and forget it. Since it has roughly the same range as a remote you will want enough devices to allow all shades to be operated without moving the controller. So depending on the layout of the home and location of the shade, you might want multiple devices to have convenient full home coverage.

**How Far Is The Range Of A Controller?**

You should see a range of approximately 150 ft. However this number might be less depending on the layout of your home. In general we recommend one per a floor of a normal sized home.

**Can I Control My Shades From Multiple Devices?**

Yes! You can download the NEO Smart Blinds App onto multiple devices, After installing the App. on a new device simply log in with the same email/password on each device and you will have access to control your shades.

**Can It Be Used With Already Installed Shades?**

Yes! Simply follow the directions in the NEO Smart Blinds app. to add a shade. At the pairing step you can put the shade in pairing mode using the primary remote control for it (or by accessing the button on the shades motor). Adding the shade to the NEO Smart Blinds App. will not affect the normal remote operation.

**How Much Does The NEO Smart Blinds App Cost?**

The app is a free download, However you must have at least one Simplicity Smart Controller to serve as a bridge between the app and your shades. See page 7.

# Color Lux® Cellular Shades

## POWERTOUCH RECHARGEABLE MOTORIZED HARDWARE SYSTEM

COLORLUX® CELLULAR SHADES

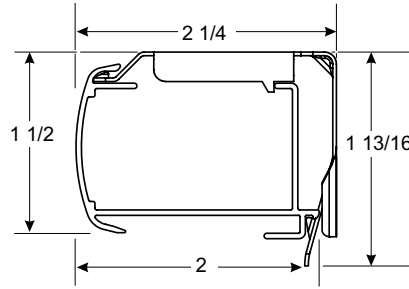

### Simplicity Motorized Rail Dimensions

- Depth of rail: 2"
- Depth of rail and bracket: 2 1/4"
- Height of rail: 1 1/2"
- Height of bracket: 1 13/16"

### Hardware Features

Standard Hardware	<ul style="list-style-type: none"> <li>• Fabric Wrapped head and bottom rails. Head rail and Bottom rails will have frosted end caps with fabric inserts.</li> <li>• Fabric used to cover the rails is the same fabric as the shade. The back of the rail will be white to the outside.</li> </ul>
Simplicity Remote	Upper and lower limit stops pre-programmed, Intermediate stop "favorites" position can be set on site.
<b>Upgrades</b>	
Designer Metallic Upgrade	<ul style="list-style-type: none"> <li>• Smooth faced Designer Oil Rubbed Bronze head, middle, bottom rails and end caps</li> <li>• Smooth faced Designer Brushed Nickel head, middle, bottom rails and end caps</li> </ul>

### Mounting Dimensions

### Simplicity Motorized Hardware System

Minimum Shallow Mount	1/2"
Minimum Flush Inside Mount	2 1/4"
Minimum Outside Mount	7/8"
Minimum Side Mount	1 1/4"
<b>Recommended Side Mounting Method</b>	<ul style="list-style-type: none"> <li>• See page 20 for recommended mounting method for side mount shades</li> <li>• Width limit for side mount brackets is 48"</li> </ul>

### Finished Dimensions

#### Inside Mount

- Fabric will measure ordered width less: 3/8"
- Head rail\* will measure ordered width less: 3/16"

#### Outside Mount

- Fabric will measure ordered width
- Head rail\* will measure ordered width plus: 3/16"

#### Side Mount

- Fabric will measure ordered width less: 7/8"
- Head rail\* will measure ordered width less: 1 1/16"

#### Exact (End Cap to End Cap) Mount

- Fabric will measure ordered width less: 3/16"
- Head rail\* will measure ordered width

\* Head rail measurements include endcaps. Width and length measurements may vary +/- 1/8"



# Color Lux® Cellular Shades

## POWERTOUCH RECHARGEABLE MOTORIZED HARDWARE SYSTEM

### PowerTouch™ Rechargeable Shades

Cellular Shades can be fabricated with the PowerTouch Rechargeable Push Button Control option. The PowerTouch Rechargeable option is an easy, cord free motorized operation for the budget savvy homeowner. PowerTouch Rechargeable uses Simplicity motors and components.

### PowerTouch Rechargeable Shades Operation

Press the up or down button on the pendant to raise or lower the shading to your desired position.

No programming is required with PowerTouch™, all programming is set at the factory. Upper and lower limits easily can be adjusted in the field if desired. Please refer to the installation instructions at [comfortex.com/](http://comfortex.com/) [comfortex-dealers.com/](http://comfortex-dealers.com/). A "favorites" or intermediate stop position can be set once installed.

### PowerTouch Rechargeable Surcharges

See page 7.

### PowerTouch Appearance

- The PowerTouch wand and pendant is attached to the head rail when installed.
- The wand and pendant hangs down the front of the shades from the head rail. The wand does not touch the fabric.
- Pendant is 2½" long.
- The pendant does not need to be mounted to the wall to operate the shade.



### PowerTouch Rechargeable Color Options

- Shades with Black or Oil Rubbed Bronze hardware will be built with black wand and pendants standard. All other colors will use white wand and pendants.



White



Black Shown with Plug-In Charger

### PowerTouch Wand and Pendant Location

The standard location for the wand and pendant is on the right. Please specify location when ordering.

### PowerTouch Rechargeable Wand Length

- The standard length of the wand will measure the indicated below unless otherwise specified.

Shading Length	Standard Wand Length
Up to 30"	1' (12")
>30" to 52"	2' (24")
>52" to 78"	3' (36")
>78" to 100"	4' (48")
>100" to 120"	5' (60")

### Mounting Requirements for PowerTouch Rechargeable Shades

- No special installation hardware or wiring requirements are needed.

### Battery Charger

8.4 Volt charger requires a standard power outlet to recharge the battery wand. Must specify charger when ordering a Simplicity Rechargeable Wand Shade. The charger plugs into the charger port. The charger is black and comes with a 156" (13') wire. The dimensions are 1" wide x 2½" length x 1¾" deep.



### PowerTouch Rechargeable Shades Warranty

Please see page 136 for complete warranty information.

Color Lux® Cellular Shades

OVATION CELLULAR SLIDER HARDWARE SYSTEM

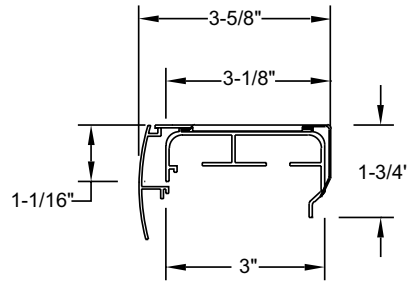

**Ovation Hardware Rail Dimensions**

- Depth of rail: 3"
- Depth of rail and bracket: 3 1/8"
- Height of rail: 1 3/4"

**Hardware Features**

Standard Hardware Color	Aspen White #785
Optional Hardware Colors	Ivory, beige, tan and gray rails are available as an option. Visit <a href="http://comfortex.com">comfortex.com</a> to view color options <ul style="list-style-type: none"> <li>• Silverado #276</li> <li>• Honey Bisque #882</li> <li>• Camel #082</li> <li>• Gardenia White #862</li> </ul>

Mounting Dimensions	Ovation Hardware System
Minimum Inside Mount	3/4"
Minimum Flush Mount	3 5/8"
Minimum Outside Mount	5/8"

**Finished Dimensions**

**Inside Flush Mount**

Track Width:	
Right or Left Stack	3/16" less than ordered width
Split Stack	3/16" less than ordered width
Center Stack	3/16" less than ordered width
Finished Slider Length	1/2" less than ordered width
Valance	3/16" less than ordered width

**Outside Mount**

Track Width	Ordered width
Finished Slider Length	Ordered length - No reductions will be made
Valance	Ordered width plus 1 1/4"
Valance Returns	Will measure 3 1/8" (standard)

# Color Lux® Cellular Shades

## OVATION CELLULAR SLIDER HARDWARE SYSTEM

### Applications

- Standard Rectangular
- Opens and closes from side to side
- Four stacking options - see below.
- Dual Panel option with a center opening design with two fabrics, one on each side, each spanning the width of the window.

### Ovation Stacking Options

Specify stacking configuration when ordering.

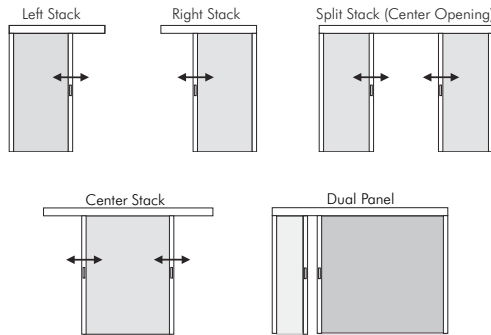

**Left:** Fabric stacks to the left side of the slider.

**Right:** Fabric stacks to the right side of the slider.

**Center Stack:** Center Stack Sliders fabric panels can move fully to the left or the right.

**Split Stack:** Fabric is split in the center of the slider forming two equal panels which open to opposite ends of the slider. Both panels will be of equal width unless otherwise specified. Split stack is not available with Gradient shades.

\* Split stack sliders are available in maximum widths from 240" to 336" (maximum width depends on the fabric selected). If the width exceeds the maximum width of the fabric, it will be fabricated as two separate sliders. The supplied valance will create the appearance of a single slider.

**Dual Panel:** A Dual Panel Stack Slider has a center opening design with a different fabric on each side, each of which can span the full width of the window. Both panels will be of equal width unless otherwise specified. Specify which fabric stacks to left and which fabric stacks to the right.

### Ordering Information for Ovation Cellular Sliders

- Specify IB or OB mount.
- Specify stacking configuration.  
On Dual Panel Shades, specify which fabric stacks to the left and right.  
On Split Stack Shades, both panels will be of equal width unless specified.
- Specify valance width and return length.

### Ovation Valance Specifications

- Every Ovation Slider is supplied with a painted aluminum valance to match your hardware color choice.
- The valance attaches to the head rail using a durable plastic clip system.

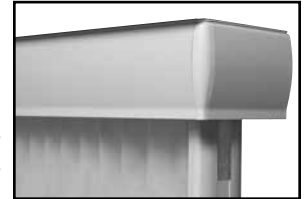

### Ovation Valance Dimensions

All valance dimensions are measured on the flat, back side.

- Valance Height: 2¾"
- Standard Return Length (OB only): 3⅛"
- For each spacer block, ½" will be added to the length of the valance returns. For extension brackets, 2" will be added unless otherwise instructed.
- If the slider requires a non-flush inside mount, you must order a custom valance. Exact valance width and exact valance return length (minimum 1½") must be specified in the Special Instructions section of the order form.
- Custom returns are available for IB non-flush and OB Cellular Sliders. Please specify return length upon ordering.

### Things to Consider

- Since most Ovations are sold in large sizes, the shade will have a large fabric stack. On an outside mount, you may want to order the shade a few inches wider so that the fabric stack can be clear of the window.
- **Minimum Ovation Stack:** Ovation's minimum fabric stack measures 6½" regardless of the ordered width. Minimum fabric stacking dimensions are determined by the slider's hardware, not ordered width.

**Color Lux® Cellular Shades**

**SIMPLICITY WAVE RECHARGEABLE MOTORIZED HARDWARE SYSTEM**

COLORLUX® CELLULAR SHADES

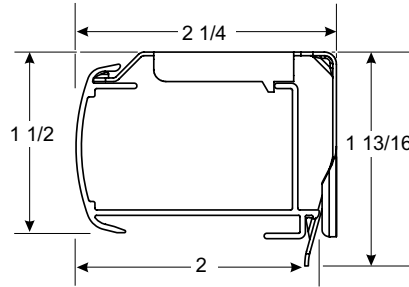

**Simplicity Rechargeable Rail Dimensions**

- Depth of rail: 2"
- Depth of rail and bracket: 2 1/4"
- Height of rail: 1 1/2"
- Height of bracket: 1 13/16"

**Hardware Features**

Standard Hardware	<ul style="list-style-type: none"> <li>• Fabric Wrapped head and bottom rails. Head rail and Bottom rails will have frosted end caps with fabric inserts.</li> <li>• Fabric used to cover the rails is the same fabric as the shade. The back of the rail will be white to the outside.</li> </ul>
Telescoping Wand	Extends to 33" to reach shades mounted high. Wand retracts to 9" for easy storage.

**Mounting Dimensions**

**Simplicity Wave Rechargeable Motorization Hardware System**

Minimum Shallow Mount	1/2"
Minimum Flush Inside Mount	2 1/4"
Minimum Outside Mount	7/8"
Minimum Side Mount	1 1/4"
<b>Recommended Side Mounting Method</b>	<ul style="list-style-type: none"> <li>• See page 20 for recommended mounting method for side mount shades</li> <li>• Width limit for side mount brackets is 48"</li> </ul>

**Finished Dimensions**

**Inside Mount**

- Fabric will measure ordered width less: 3/8"
- Head rail\* will measure ordered width less: 3/16"

**Outside Mount**

- Fabric will measure ordered width
- Head rail\* will measure ordered width plus: 3/16"

**Side Mount**

- Fabric will measure ordered width less: 7/8"
- Head rail\* will measure ordered width less: 1 1/16"

**Exact (End Cap to End Cap) Mount**

- Fabric will measure ordered width less: 3/16"
- Head rail\* will measure ordered width

\* Head rail measurements include endcaps. Width and length measurements may vary +/- 1/8"

# Color Lux® Cellular Shades

## SIMPLICITY WAVE RECHARGEABLE MOTORIZED HARDWARE SYSTEM

### Wave Rechargeable Simplicity Motor

The Simplicity Wave Motor features a battery powered motor utilizing a rechargeable battery hidden inside the shade head rail. Simplicity wave motors are compact and use a telescoping wand to raise or lower the shades.

Wave Rechargeable Motorized Lift Systems are not offered on sizes within the shaded area on the Standard Rectangular price grids.

### Applications

- Rectangular

### EZ Level

Learn about the EZ Level feature on page 55.

### Simplicity Wave Rechargeable Motorization Surcharges

The Simplicity Wave Rechargeable Motorized Lift System surcharge includes a rechargeable battery. A Wand is needed to operate the shades and a charger to charge the battery. Refer to pricing pages.

### Ordering Information for Rechargeable Motorized Cellular Shades

#### Simplicity Motor Option

- Specify IB or OB mount and rail color.
- Specify wand and other accessories if needed.
- Specify one or more battery chargers.

#### Please Note:

- Not all motors run at the same rate of speed.
- Simplicity Wave Rechargeable Motorized Cellular Shades are programmed at the factory with the "up and down" limits.
- Favorites position can be set on site.
- **REMEMBER: Order at least one charger if ordering rechargeable motors.**

SIMPLICITY RECHARGEABLE BATTERY WAND PRICING EXAMPLE:	
Linen Weave	
Light Filtering 42" x 60" Shade:	\$407.00
Simplicity Wave Surcharge:	\$132.00
Charger for Wave Rechargeable:	\$30.00
Simplicity Wave Wand:	\$30.00
<b>Total List Price:</b>	<b>\$599.00</b>

### Simplicity Wave Rechargeable Battery

The rechargeable battery is concealed in the head rail of the shade. A charger is required for the rechargeable battery. The rechargeable battery comes fully charged from the factory.

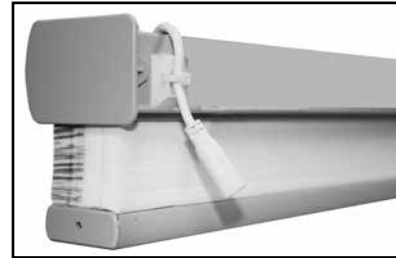

Charging Port on Back of Head rail.

### Simplicity Rechargeable Battery Life

Rechargeable batteries are included with the motor.

The average battery charge will last 6-12 months based on an average sized shade raised and lowered once per day. The life of the battery charge will vary based on the type of window covering selected, the size and weight of the window covering and the number of times the shade is operated on a daily basis.

The battery can be recharged up to 500 times. It takes approximately 5 hours to recharge the motor when fully depleted.

### Battery Charger

8.4 Volt charger requires a standard power outlet to recharge the battery pack. Must specify charger when ordering a Simplicity Rechargeable Wand Shade. The charger plugs into the charger port. The charger is black and comes with a 156" (13') wire. The dimensions are 1" wide x 2 1/2" length x 1 3/4" deep.



### Telescoping Wand

- Extends to 33" to reach shades mounted high.
- Wand retracts to 9" for easy storage.
- The wand is silver with white handle and white magic tip.
- Wall mount plate included for convenience.
- Wand is universal and will operate all Simplicity Wave shades



### Simplicity Motorized Shade Warranty

Please see page 136 for complete Comfortex warranty information.

# The Ultimate Blackout Color Lux® Cellular Shade

## INSULATING SLUMBERSHADES HARDWARE SYSTEM

COLORLUX® CELLULAR SHADES



### Deluxe Head Rail

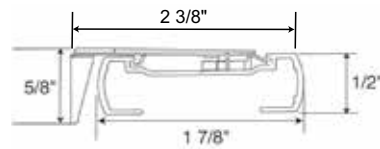

### Cord Loop & Cordless Ultra Head Rail (Standard & Top Down-Bottom Up)

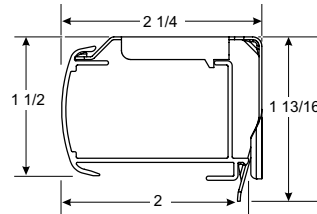

### Deluxe Cord Lock Rail

- Depth of rail: 1 7/8"
- Depth of rail and bracket: 2 3/8"
- Height: 1/2"
- Height of bracket: 5/8"

### Cord Loop & Cordless Ultra Rail

- Depth of rail: 2"
- Depth of rail and bracket: 2 1/4"
- Height of rail: 1 1/2"
- Height of bracket: 1 13/16"

Hardware Features	
Hardware colors for all Cellular fabrics	Fabric wrapped head, middle, bottom rails and end caps is standard. Back of rail is white to outside.
Blackout Sidetrack Colors Available	White, Tan and Bronze
Upgrades	
Designer Metallic Upgrade	• Oil Rubbed Bronze and Brushed Nickel head, middle, bottom rails and end caps.
Mounting Dimensions (inside mount only)	
Deluxe Head Rail	
Standard Cord Lock (Standard Retangular and Top Down-Bottom Up)	
Minimum Inside Mount	1 1/2"
Minimum Flush Inside Mount	2 3/8"
Cord Loop & Cordless Ultra (Standard Retangular and Top Down-Bottom Up)	
Minimum Inside Mount	1 1/2"
Minimum Flush Inside Mount	2 3/8"
<b>Outside, shallow and side mounts are not available.</b> The shade's light blocking ability is compromised by using any other mount than a fully flush mount application.	
Finished Dimensions	
Inside Mount	
	<ul style="list-style-type: none"> <li>• Fabric will measure ordered width less: 7/8"</li> <li>• Head rail and bottom rail will measure ordered width less: 1 1/16"</li> <li>• Sidetrack length will measure ordered length less: 1/8"</li> </ul>

The widest width of the window cannot exceed the narrowest width of the window by more than 1/4".

**Precise width measurements are critical to proper performance of SlumberShade products.** Make sure to measure to the nearest 1/16" and provide the NARROWEST width measurement along the length of the window. Be sure to measure the top, middle and bottom of the opening. It is very common for the width of a window to vary from top to bottom.



# The Ultimate Blackout Color Lux® Cellular Shade

## INSULATING SLUMBERSHADES HARDWARE SYSTEM

### Applications

- Standard Rectangular • Top Down - Bottom Up
- Cordless and Cordless Top Down - Bottom Up
- Cord Loop and Top Down - Bottom Up

**SlumberShades are for inside mount applications only.**

### Insulating SlumberShade Fabric

Light Filtering fabrics are available as SlumberShades, however the best light control is achieved by using a blackout cellular fabric. Not available in Boutique fabric.

### Ordering Information for Insulating SlumberShades

SlumberShades are for inside mount applications only.

**Precise width measurements are critical to proper performance of SlumberShade products.** Make sure to measure to the nearest 1/16" and provide the **NARROWEST** width measurement along the length of the window. Be sure to measure the top, middle and bottom of the opening. It is very common for the width of a window to vary from top to bottom. The widest width of the window cannot exceed the narrowest width of the window by more than 1/4".

If you have questions about ordering SlumberShades, contact Comfortex Technical Services at 800-843-4151.

### Accessories

- 6' Expandable Pole:
- 12' Expandable Pole:

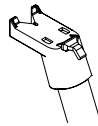

Specially designed pole end fits into the handle on the Cordless Ultra bottom rail and allows for easy operation.

### Insulating SlumberShades Features

Use SlumberShades to provide the darkest sleeping environment by sealing out the highest percentage of light.

### Energy Saving Blackout Sidetracks

Energy saving blackout sidetracks are made from a durable window grade PVC. The blackout sidetracks seal off the light gap between the blackout cellular shade and the window. The blackout sidetracks feature a black interior lining to absorb light and prevent it from entering the room.



### Insulating SlumberShades Large Track Dimensions Used with all fabrics that utilize the deluxe sized head rail.

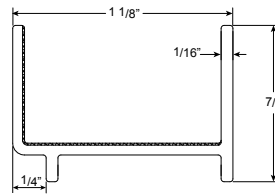

#### Large Track

- Width of track: 1 1/8"
- Height of track: 7/8"

SlumberShades are easy to install, and feature removable sidetracks that are attached to the window frame with magnets. The sidetracks can be removed for window cleaning. The UV stable, window grade PVC sidetracks are available in white, tan and bronze to match your existing trim.

**Please Note:** When properly installed, SlumberShades block 99% of all visible light. In certain installations with intense sunlight, a very small amount of light may reflect around the edges of the honeycomb fabric along each side of the shade. This is a normal attribute of the SlumberShade system.

### Insulating SlumberShade End Caps

The specially designed notched bottom rail end caps fit over the blackout sidetracks and allow for smooth movement when raising and lowering the shade.

### Head and Bottom Rail Seals

To ensure a perfectly dark sleeping environment, additional fuz bar are supplied to be placed along the shade's bottom rail and between the head rail and the window frame if needed. These barriers provide a complete light stop all the way around the window to keep all exterior light out. Also, these additional seals provide a very effective barrier against heat loss along your windows.

Magnets and fuzz bar are standard on Cordless and Cordless Top Down-Bottom Up Shades to ensure closure between the bottom rail and window sill.

### Energy Efficiency

Independent testing has shown SlumberShades provide an R-value greater than 7.0\* when installed over a double paned vinyl window. The testing also indicates that the R-value of a SlumberShade is 2.5 to 3 times higher than that of the same shade without sidetracks. The insulating cellular fabric, sidetracks, and fuz bar all ensure that the SlumberShades provides superior energy efficiency.

\* Independent testing provided by Consortium for Advanced Residential Buildings (CARB), a U.S. Department of Energy Building America research team. Learn more at [comfortex.com](http://comfortex.com).

### EZ Level

Learn about the EZ Level feature on page 55.



**Color Lux® Cellular Shades**  
**STRATAVIEW™ HARDWARE SYSTEM**

COLORLUX® CELLULAR SHADES

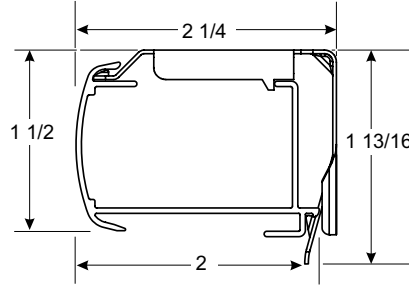

**Cord Loop, Cordless Ultra & Simplicity Rechargeable Rail Dimensions**

- Depth of rail: 2"
- Depth of rail and bracket: 2 1/4"
- Height of rail: 1 1/2"
- Height of bracket: 1 13/16"

A sheer top fabric panel and your choice of Color Lux fabric as the bottom panel.

**Hardware Features**

Fabric Wrapped	Fabric wrapped head rail to match color of top sheer or bottom fabric, middle and bottom fabric wrapped rails will match bottom fabric selection. Back of rail is white to outside. Frosted clear with fabric insert end caps. Clutch cover and Cordloop is white on cordloop shades.
Designer Metallic	<ul style="list-style-type: none"> <li>• Oil Rubbed Bronze head and bottom rails with bronze end caps and white cord.</li> <li>• Brushed Nickel head and bottom rails and end caps with white cord.</li> </ul>

**Mounting Dimensions**

**Hardware System - Cord Loop , Cordless Ultra & Simplicity Rechargeable**

Minimum Shallow Mount	1/2"
Minimum Flush Inside Mount	2 1/4"
Minimum Outside Mount	7/8"
Minimum Side Mount	1 1/4"
<b>Recommended Side Mounting Method</b>	<ul style="list-style-type: none"> <li>• See figure A, page 20 for recommended mounting method for side mount shades</li> <li>• Width limit for side mount brackets is 48"</li> </ul>

**Finished Dimensions**

**Inside Mount**

- Fabric will measure ordered width less: 3/8"
- Head rail\* will measure ordered width less: 3/16"

**Outside Mount**

- Fabric will measure ordered width
- Head rail\* will measure ordered width plus: 3/16"

**Side Mount**

- Fabric will measure ordered width less: 7/8"
- Head rail\* will measure ordered width less: 1 1/16"

**Exact (End Cap to End Cap) Mount**

- Fabric will measure ordered width less: 3/16"
- Head rail\* will measure ordered width

\* Head rail measurements include endcaps. Width and length measurements may vary +/- 1/8"



Top Panel and Bottom Panel



Bottom Panel Raised



Top Panel Lowered

# Color Lux® Cellular Shades

## STRATAVIEW™ HARDWARE SYSTEM

### StrataView™

StrataView is a dual panel shade featuring a sheer top fabric panel and your choice of Color Lux fabric as the bottom panel.

### Hardware Options

- Cord Loop
- Cordless Ultra
- TDBU Simplicity Rechargeable Motorization

### Cord Loop Hardware System

See page 19 for details.

### Cordless Ultra Hardware System

See page 21 for details.

### Simplicity Rechargeable Motorized Hardware System

See page 25 for details.

### Recommended Mounting Method for Side Mounting Shades

See Page 20.

### EZ Level on Cellular Shades

EZ Level makes quick work of leveling without cords to cut or tuck into a rail. Middle rail can not be adjusted in the field. See page 55 for details.

### StrataView Fabric Specifications

Sheer fabric is always on the top of the shade. See fabric samples of the 3 sheer fabrics for the top of the StrataView in the Color Lux Sample Book.

#### BOTTOM FABRICS

CELLULAR	Width		Length	
	Min	Max	Min	Max
Cordless	18" OB 18¾" IB	96"	8"	84"
Cordloop	22"	108"	8"	120"
Motorized	24" OB 24¾" IB	108"	8"	120"

Motorized StrataView Shades less than 36" in width require an external mounted battery. See pages 28 & 29

### MOTORIZED STRATAVIEW TOP DOWN-BOTTOM UP PRICING EXAMPLE:

Linen Weave	
Light Filtering 42" x 60" Shade:	\$407.00
Simplicity Rechargeable Surcharge:	\$786.00
Charger for Rechargeable:	\$30.00
TDBU Remote Control:	\$72.00
<b>Total List Price:</b>	<b>\$1295.00</b>

### Ordering Information for StrataView Shades

#### Cord Loop StrataView

- Specify IB or OB mount and rail color.
- Middle and bottom rail will match the bottom fabric. Top rail can match top or bottom fabric, your choice.
- Specify cord loop length when ordering.
- Controls are the right cord loop operates the middle rail and left cord loop operates the bottom. Reverse controls are not available.

#### Cordless Ultra StrataView

- Specify IB or OB mount and rail color.
- Middle and bottom rail will match the bottom fabric. Top rail can match top or bottom fabric, your choice.

#### Accessories

- 6' Expandable Pole:
- 12' Expandable Pole:

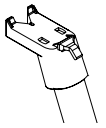

Specially designed pole end fits into the handle on the Cordless Ultra bottom rails and allows for easy operation.

#### Simplicity Rechargeable StrataView

- Specify IB or OB mount and rail color.
- Middle and bottom rail will match the bottom fabric. Top rail can match top or bottom fabric, your choice.
- Specify remote and other accessories if needed.
- Specify one or more battery chargers.

### StrataView Simplicity Motor Hand Held Remote 14 Channel Remote

The TDBU remote has 14-channels. Each channel has a setting to operate the middle rail and a setting to operate the bottom rail. The TDBU remote is required for StrataView motors. The **14 Channel TDBU remote** can operate up to fourteen shades individually or 14 groups. Simplicity Rechargeable Motorized Cellular Shades are programmed at the factory with the "up and down" limits. The shades are **UNLINKED** from the remote so they are not able to operate during shipping. Each shade should be installed **after** linking it to the remote.



Simplicity TDBU remotes and holders are white in color. The remote comes with a holder which can be mounted to a wall for easy storage. The range of the remote is approximately 80 feet.

**REMEMBER: Order at least one charger if ordering rechargeable motor**

### Recommended Mounting Method for Side Mounting Shades

See Page 20.

**Color Lux® Cellular Specialty Shades**  
**STARBURST ARCHES HARDWARE SYSTEM**

COLORLUX® CELLULAR SHADES

**Stationary Starburst**

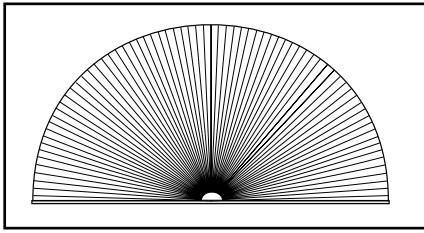

Figure A

**Movable Starburst**

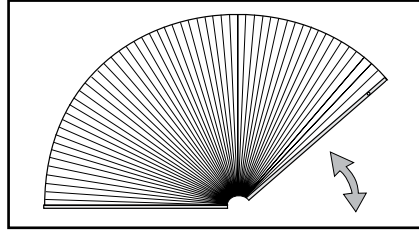

Figure B

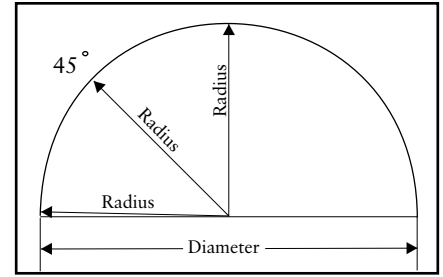

Figure C

**Hardware Features | See Page 17 for Rail Dimensions**

Standard Hardware	Fabric wrapped rail is standard. The fabric will be spliced in the center of the rail. A decorative rosette is supplied to conceal the splice.
Designer Metallic	<ul style="list-style-type: none"> <li>• Oil Rubbed Bronze rails with bronze colored end caps.</li> <li>• Brushed Nickel rails and end caps.</li> </ul>

**Mounting Dimensions**

Mounting Dimensions	Standard Cord Lock Rail
Minimum Shallow Mount	3/4"
Minimum Flush Inside Mount	2 3/8"
<b>Recommended Side Mounting Method</b>	<ul style="list-style-type: none"> <li>• See figure A, pg 20 for recommended mounting method for side mount shades</li> <li>• Width limit for side mount brackets is 48"</li> </ul>

**Finished Dimensions**

**Inside and Side Mount**

<ul style="list-style-type: none"> <li>• Fabric will measure ordered width less: 3/8"</li> <li>• Head rail* will measure ordered width less: 3/16"</li> </ul>	<ul style="list-style-type: none"> <li>* Head rail measurements include endcaps.</li> <li>Width and length measurements may vary +/- 1/8"</li> </ul>
---	--

**Applications**

- Stationary Fan Style Arch
  - Movable Fan Style Arch
- Movable Starburst Arch shades are for inside and shallow mount applications only.

**Stationary Starburst Features (Figure A)**

- **All non-perfect Stationary Starburst arches require a template made from brown craft paper.** Comfortex offers template kits. Please contact Customer Service to order. Stock number: 751000, See page 133
- A perfect arch is twice as wide as it is high.
- Stationary Starburst shades which are not perfect half circles must have a height that equals half the width +/- 5".
- Price according to the largest radius measurement. If the height is greater than the width, take height X 2 and use that number to determine pricing.
- When ordering arches as perfect half-circles make sure the radius of the arch remains constant to ensure a proper fit. (See Figure C)

**Movable Starburst Features (Figure B)**

- Starburst Movable archtop shades are cut to perfect half circles only and do not require a template. The height must be exactly 1/2 the diameter.
- A perfect arch is twice as wide as it is high.
- When ordering arches as perfect half circles make sure the radius of the arch remains constant to ensure a proper fit. (See Figure C)
- The hinge gap (gap between the two rails) is not centered in the window. The moving rail is always smaller than the stationary rail to provide proper movement within the window.

**Accessories**

- 6' Expandable Pole:
- 12' Expandable Pole:

Specially designed pole end fits into the handle on movable Starburst Shades for easy operation.



# Color Lux® Cellular Specialty Shades

## QUARTER ROUNDS HARDWARE SYSTEM

### Movable Quarter Round

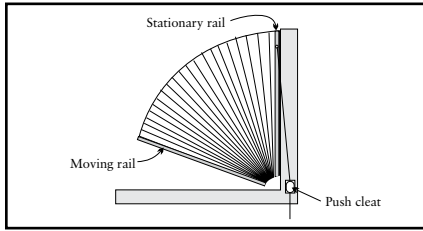

Figure A

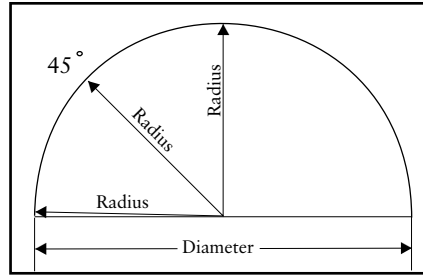

Figure B

### Stationary Quarter Round

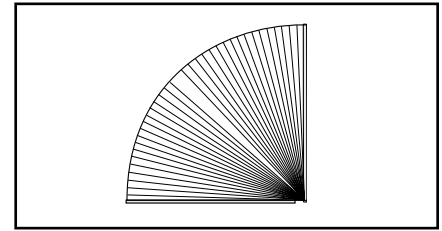

Figure C

### Hardware Features | See Page 17 for Rail Dimensions

Hardware colors for all Cellular and Pleated fabrics | Fabric wrapped rails with white cord and tassel. Fabric used is same fabric as the shade. Back of rail is white to outside.

### Upgrades

- Designer Metallic Upgrade
- Oil Rubbed Bronze rails and endcaps, bronze colored tassel and white cord.
  - Brushed Nickel rails and end caps with coordinating tassel and white cord.

Mounting Dimensions	Standard Rail	Deluxe Rail
Minimum Shallow Mount	3/4"	3/4"
Minimum Flush Inside Mount	2"	2 3/8"
Minimum Outside Mount	3/4"	3/4"
Minimum Side Mount	1 1/8"	1 3/8"
<b>Recommended Side Mounting Method</b>	• See page 20 figure A for recommended mounting method for side mount shades	

### Finished Dimensions

#### Inside and Side Mount

- Fabric will measure ordered width less: 3/8"
- Head rail\* will measure ordered width less: 3/16"

#### Outside Mount

- Fabric will measure ordered width
- Head rail\* will measure ordered width plus: 3/16"

#### Exact (End Cap to End Cap) Mount

- Fabric will measure ordered width less: 3/16"
- Head rail\* will measure ordered width

\* Head rail measurements include endcaps.  
Width and length measurements may vary +/- 1/8"

### Applications

- Stationary Fan Style Quarter Round
- Movable Fan Style Quarter Round

### Accessories

- 6' Expandable Pole:
- 12' Expandable Pole:



### Ordering Information for Quarter Rounds Shades

- Specify IB or OB mount and rail color.
- Include a template if the shade is a non-perfect quarter round.

Specially designed pole end fits into the handle on movable Quarter Round Shades for easy operation.

## Color Lux® Cellular Specialty Shades QUARTER ROUNDS HARDWARE SYSTEM

### Quarter Rounds Features (Figure B, page 42)

- **All Quarter Round Shades which are not perfect quarter circles require a template.** Price according to the largest radius measurement.
- See page 133 for template instructions.
- **All templates should be made from brown craft paper.** Comfortex offers template kits. Please contact Customer Service to order. Stock number: 751000
- The horizontal (moving) rail of a Movable Quarter Round shade **must be smaller** than the vertical (stationary) rail to allow clearance for the moving rail. The shade will stack in the vertical position.
- When ordering arches as perfect quarter circles, make sure the radius of the arch remains constant to ensure a proper fit. (See Figure B, page 44)



# Color Lux® Cellular Specialty Shades

## SUNSET ARCHES HARDWARE SYSTEM

### Movable Sunset

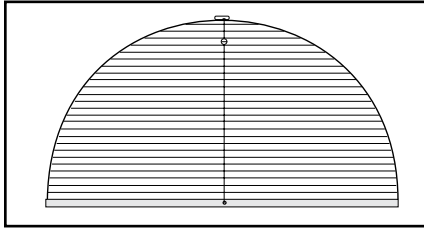

Figure A

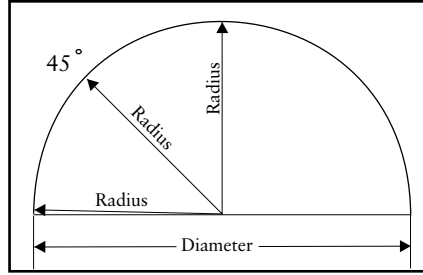

Figure B

### Two-String Hanging Method

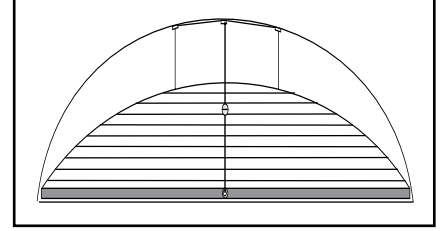

Figure C

### Hardware Features | See Page 17 for Rail Dimensions

Fabric Wrapped	Fabric used is same fabric as the shade. Back of rail is white to outside. Clear frosted end caps, white cord and silver tassel
Designer Metallic	<ul style="list-style-type: none"> <li>• Oil Rubbed Bronze rails with bronze colored end caps and white cord.</li> <li>• Brushed Nickel rails and end caps with white cord.</li> </ul>

### Mounting Dimensions

#### Standard Cord Lock Rail

Minimum Shallow Mount	3/4"
Minimum Flush Inside Mount	2 3/8"
Minimum Outside Mount	3/4" Outside mounting requires the use of an extension "L" bracket for the mounting of the top block.
Minimum Side Mount	1 1/8"
Recommended Side Mounting Method	<ul style="list-style-type: none"> <li>• See page 20, figure A for recommended mounting method for side mount shades</li> <li>• Width limit for side mount brackets is 48"</li> </ul>

### Finished Dimensions

#### Inside and Side Mount

- Fabric will measure ordered width less: 3/8"
- Head rail\* will measure ordered width less: 3/16"

#### Outside Mount

- Fabric will measure ordered width
- Head rail\* will measure ordered width plus: 3/16"

#### Exact (End Cap to End Cap) Mount

- Fabric will measure ordered width less: 3/16"
- Head rail\* will measure ordered width

\* Head rail measurements include endcaps.  
Width and length measurements may vary +/- 1/8"

### Applications

- Movable Arch

### Ordering Information for Sunset Shades

- Specify IB or OB mount and rail color.
- Include a template if the shade is a non-perfect arch.

### Accessories

- 6' Expandable Pole:
- 12' Expandable Pole:



Specially designed pole end fits into the ball on Sunset Shades for easy operation.

# Color Lux® Cellular Specialty Shades

## SUNSET ARCHES HARDWARE SYSTEM

### Sunset Features and Ordering Notes

(Figure A, pg 44)

- Sunset shades have horizontal pleats that stack at the bottom, on a stationary sill rail. Sunset shades are operated by a continuous cord that runs through a top mount guide block and back down through the stationary rail. A moving metal ball attached to the cord is used to raise and lower the shade. (See Figure E).
- **All Sunset arches which are not perfect half circles require a template.** A perfect arch is twice as wide as it is high. See page 133 for template instructions.
- **All templates should be made from brown craft paper.** Comfortex offers template kits. Please contact Customer Service to order. Stock number: 751000
- Sunset shades which are not perfect half circles must have a height which is equal to or greater than 25% of the width.
- When ordering Sunset shades that are perfect half circles, make sure the radius of the arch remains constant to ensure a proper fit. (See Figure B).
- **Stringing Method:** Depending on the curvature of a particular arch, it may be necessary to use the two string method (See Figure C) to ensure proper fit and operation of your Sunset shade. Comfortex will determine the best stringing method after examination of the template.
- **Arch Styles:** Sunset arches are available in a variety of styles including: palladium, eyebrow and bullet shaped arches. (See Figure D).

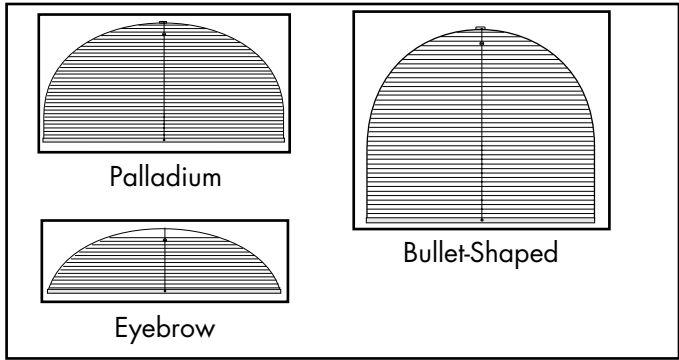

Figure D

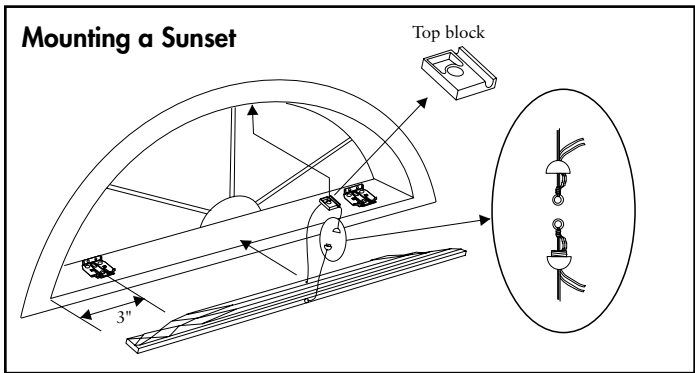

Figure E

### Recommended Mounting Method for Side Mounting Shades

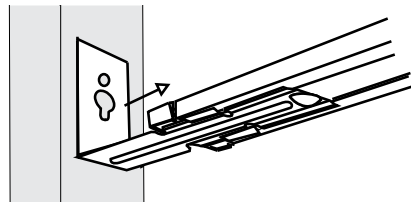

Figure F

Refer to the installation instructions on [Comfortex.com](http://Comfortex.com) or the OnDemand Mobile Library for further details on side mounting shades.



# Color Lux® Cellular Specialty Shades

## TRAPEZOIDS AND OCTAGONS HARDWARE SYSTEM

### Movable Trapezoids

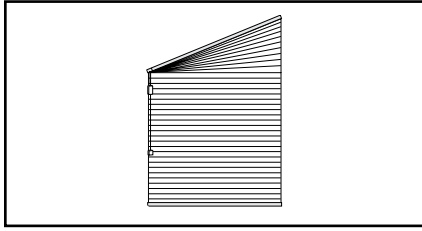

### Movable Octagons

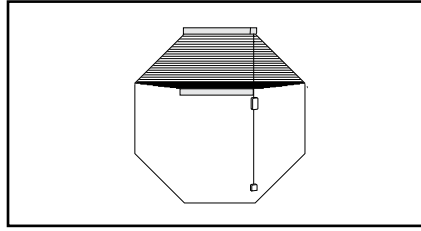

Hardware Features   See Page 17 for Rail Dimensions	
Fabric Wrapped	Fabric used is same fabric as the shade. Back of rail is white to outside. Frosted clear end caps with white cord and tassel
Designer Metallic	<ul style="list-style-type: none"> <li>• Oil Rubbed Bronze head and bottom rails with bronze colored tassel, end caps and white cord.</li> <li>• Brushed Nickel head and bottom rails and end caps with coordinating tassel and white cord.</li> </ul>
Mounting Dimensions	
	Standard Cord Lock Rail
Minimum Shallow Mount	3/4"
Minimum Flush Inside Mount	2"
Minimum Outside Mount	3/4"
Minimum Side Mount	1 1/8"
<b>Recommended Side Mounting Method</b>	<ul style="list-style-type: none"> <li>• See page 20 for recommended mounting method for side mount shades</li> <li>• Width limit for side mount brackets is 48"</li> </ul>
Finished Dimensions	
Inside and Side Mount	
	<ul style="list-style-type: none"> <li>• Fabric will measure ordered width less: 3/8"</li> <li>• Head rail* will measure ordered width less: 3/16"</li> </ul>
Outside Mount	
	<ul style="list-style-type: none"> <li>• Fabric will measure ordered width</li> <li>• Head rail* will measure ordered width plus: 3/16"</li> </ul>
Exact (End Cap to End Cap) Mount	
	<ul style="list-style-type: none"> <li>• Fabric will measure ordered width less: 3/16"</li> <li>• Head rail* will measure ordered width</li> </ul>
* Head rail measurements include endcaps. Width and length measurements may vary +/- 1/8"	

### Applications

- Movable Trapezoids
- Movable Octagons

### Ordering Information for Trapezoid Shades

- Specify IB or OB mount and rail color.
- **Trapezoid orders must be faxed or emailed in with a diagram. Please provide measurements for all four sides when ordering. No template is required.**

### Ordering Information for Octagon Shades

- Specify IB or OB mount and rail color.
- **The width, length and one side are required measurements when ordering.**

# Color Lux® Cellular Specialty Shades

## TRAPEZOIDS AND OCTAGONS HARDWARE SYSTEM

### Trapezoids (Figure A)

- Trapezoid orders must be faxed in with a diagram. Please provide measurements for all four sides when ordering. No template is required.
- The maximum slope of the top rail is 30 degrees from horizontal. Slope is the angle between slope and a horizontal line. The slope angle must be measured with a protractor.
- Sides of trapezoid must be parallel.
- Sill must be level for proper installation and operation of a trapezoid shade.
- Operating cord must be placed on the short side.
- See Figures B and C for trapezoid shade operation.

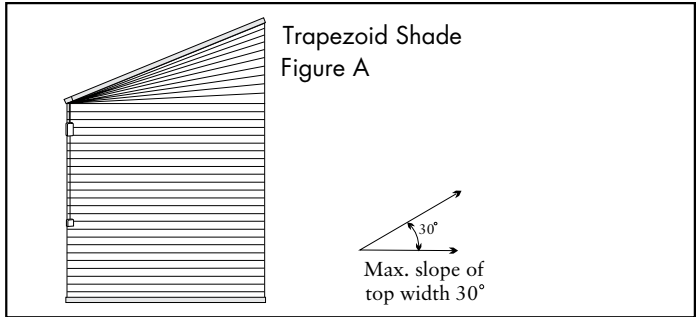

### Octagons

- The width, length and one side are required measurements when ordering.
- Octagon shades raise only to the point where the top angle begins. (See Figure D)
- See Figure A on page 20 for recommend mounting method for side mount shades.
- Width limit for side mount brackets is 48".

### Trapezoid Shade Operation

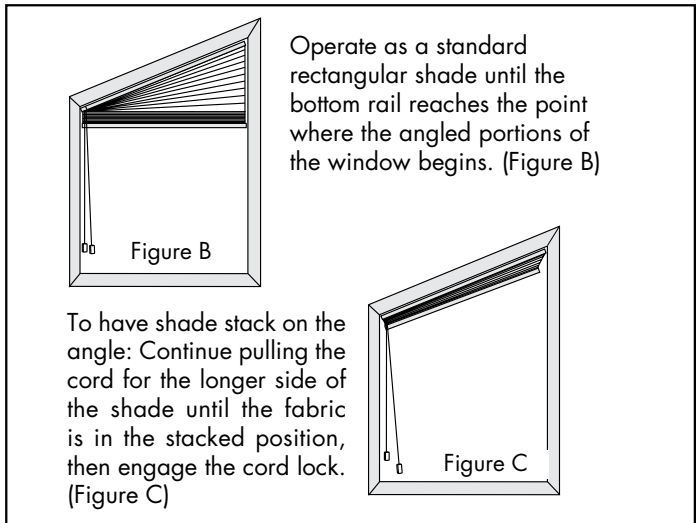

### Octagon Operation

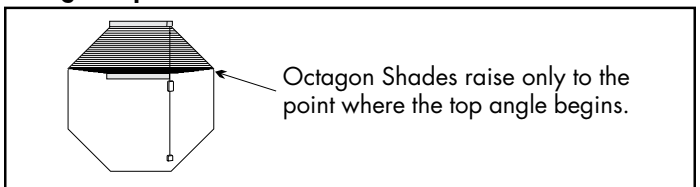
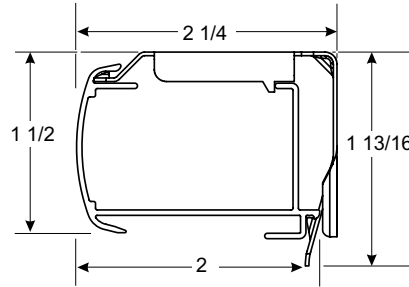

Figure D



**Color Lux® Cellular Specialty Shades**

**MEZZO MOTORIZED SKYLIGHT HARDWARE SYSTEM**



**Simplicity Motorized Rail Dimensions**

- Depth of rail: 2"
- Depth of rail and bracket: 2 1/4"
- Height of rail: 1 1/2"
- Height of bracket: 1 13/16"

<b>Hardware Features</b>	
Hardware colors	White head, bottom and side rails
Simplicity Remotes	Upper and lower limit stops pre-programmed, Intermediate stop "favorites" position can be set on site, 5 channel, 6 channel timer or 14 channel option

<b>Mounting Dimensions</b>	<b>Mezzo Motorized Skylight Shades</b>
Minimum Flush Inside Mount	2 1/2"
	<ul style="list-style-type: none"> <li>• Should not be more than 1/2" out of square to perform as intended</li> <li>• The widest width of the window cannot exceed the narrowest width of the window by more than 3/8".</li> <li>• The shade must be mounted with the fabric stack at the bottom or the lowest point of the window</li> </ul>
	See page 49 for Solar Panel information.

<b>Finished Dimensions</b>	
<b>Inside Mount</b>	
	<ul style="list-style-type: none"> <li>• Fabric will measure ordered width less: 1 1/4"</li> <li>• Head rail* will measure ordered width less: 3/16"</li> </ul>
* Head rail measurements include endcaps. Width and length measurements may vary +/- 1/8"	

<b>MOTORIZATION - HARDWARE UPGRADE SURCHARGES AND ACCESSORIES   All standard discounts apply to motorized shades</b>		<b>ADD</b>
	Simplicity - Motor and Rechargeable Battery Pack	\$368
	Simplicity 5 Channel Remote	\$44
	Simplicity 6 Channel Remote with Timer	\$72
	Simplicity 14 Channel White Remote	\$72
	48" Extension Wire:	\$19
	Simplicity Smart Controller (NEO)	\$363
	Solar Panel with brackets	\$110
	Plug In Charger: for rechargeable battery pack	\$30

**Ordering Information for Mezzo Motorized Skylight Shades**

- Specify inside mount dimensions.
- Specify fabric color and style.
- Specify remote and other accessories if needed.

# Color Lux® Cellular Specialty Shades

## MEZZO MOTORIZED SKYLIGHT HARDWARE SYSTEM

### Applications

- Horizontal, Angled and Vertical motorized skylight shades.

Mezzo Motorized Skylight Shades are for inside mount applications only.

### Mezzo Power Options

- Simplicity Rechargeable Motor

### RECHARGEABLE SIMPLICITY MOTORS

The Simplicity Motor program features a battery powered motor utilizing a rechargeable battery hidden inside the shade head rail. Simplicity motors are compact and use a radio frequency remote to raise or lower the shades.

### Simplicity Rechargeable Battery

The rechargeable battery is concealed in the head rail of the shade. A charger is required for the rechargeable battery. The rechargeable battery comes fully charged from the factory.

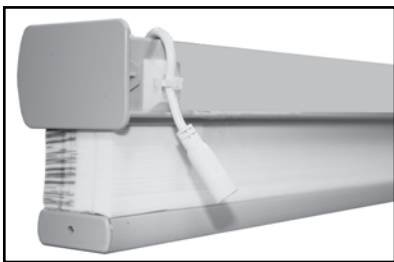

Charging Port on Back of Head rail.

### Simplicity Hand Held Remotes

The 5 Channel remote can operate up to five shades individually or in groups. **WHEN ORDERING PLEASE SPECIFY WHICH CHANNELS ARE ASSIGNED TO EACH SHADE OR GROUP OF SHADES.** For example; program line 1 to channel 1, line 2 and 3 to channel 2, etc. If no channels are assigned at time of order, all shades will be programmed to Channel 1. **To reprogram channel assignments, please refer to the installation instructions and/or view the video at [comfortex.com/comfortex-dealers](http://comfortex.com/comfortex-dealers).**



A **6 Channel (6C) timer remote** is also available. See page 31 for more information

Simplicity remotes are black and holders are white or black in color. The remote comes with a holder which can be mounted to a wall for easy storage. The range of the remote is approximately 80 feet.

The Simplicity remote utilizes one 3V battery (CR2032). Batteries are included. Comfortex will warranty batteries for up to 3 months from date of purchase. Batteries are not covered by the warranty.

A **14 Channel (14C) remote** is also available. This remote is required for TDBU motorization but can be utilized on all Simplicity motorized shades. See page 29 for more information.

### Solar Panel Recharge Option

Plugs in to any Simplicity Rechargeable Remote control shade (does not work with PowerTouch)

Provides constant trickle charge to 7.4v Li-Ion Rechargeable battery packs. Does not require direct sunlight, but performs best in regular direct sunlight applications. Will prolong the life of the charge of the 7.4v rechargeable battery packs, and in some applications will maintain charge indefinitely.

Life of charge is subject to application variables such as, size and weight of shade, frequency of use, amount of direct sunlight exposure, etc.



Dimensions of panel  
18½" x 1½"

### Solar Recharge Optimum Application

- Full direct sunlight (minimum 4-6 hours per day) to maintain full charge. Based on one operation cycle per day (one open, one close).
- Solar panel will charge batteries even without direct sunlight. Ambient light will charge the batteries but at a slower rate.
- Excessive duration of cloudy weather will impact the rate of charge.

### Battery Charger

8.4 Volt charger requires a standard power outlet to recharge the battery wand. Must specify charger when ordering a Simplicity Rechargeable Wand Shade. The charger plugs into the charger port. The charger is black and comes with a 156" (13') wire. The dimensions are 1" wide x 2½" length x 1¾" deep.



# Color Lux® Cellular Specialty Shades

## MEZZO MOTORIZED SKYLIGHT HARDWARE SYSTEM

### Solar Panel Location Requirements

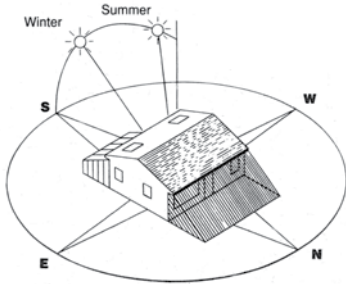

#### For Locations North of Washington, DC (39° Latitude)





#### For Locations South of Washington, DC (39° Latitude)



- Assumptions:** 1) Window area free from shadows 9 AM to 3 PM.  
2) Glazing is double pane, clear.

Excessive shading or tinted glass will impact the solar charging capability of the system.

-  Indicates orientations which may require periodic manual recharge with Plug In Charger.
-  Indicates orientations which are optimum for solar recharge (wireless systems).

### Retrofit Existing Standard Simplicity Motorized Shades with Rechargeable Batteries

Cellular shades made with Standard Simplicity Motorization can be retrofitted with the Rechargeable Simplicity Motorization Battery Wand. The Rechargeable battery wand is 22" long, comes with 10 NiMH batteries, and is white in color. Battery wands are charged at the factory.



Battery Wand for Rechargeable Simplicity Retrofit

Please contact customer service for more information.  
Please note: Retrofit wand does not work with solar panels.

### Important Simplicity Motorized Shades Operating and Installation Information

- Simplicity Motorized Shades installed into windows with metal casings may have a reduced radio frequency range, or may not operate at all, depending on the application.
- Do not let the antenna on the motor touch any metal objects. This may interfere with signals from the remote control.
- Make sure to leave the top of the shade head rail open (motor exposed), do not cover; especially with metal materials. This could result in a reduced radio frequency range for the remote control or the shade may not operate at all, depending on the application.



# Color Lux® Cellular Specialty Shades

## FRENCH DOOR DÉCOR HARDWARE SYSTEM



**Deluxe Head Rail**

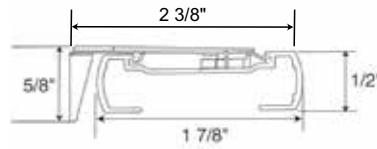

**Deluxe Rail**

- Depth of rail: 1 7/8"
- Depth of rail and bracket: 2 3/8"
- Height: 1 1/2"
- Height of bracket: 5/8"

<b>Hardware Features</b>	
Fabric Wrapped Upgrade	Fabric used is same fabric as the shade. Back of rail is white to outside. Frosted clear end caps with fabric insert.
Designer Metallic Upgrade	<ul style="list-style-type: none"> <li>• Oil Rubbed Bronze head, middle, bottom rails and end caps.</li> <li>• Brushed Nickel head, middle, bottom rails and end caps.</li> </ul>

<b>Mounting Dimensions</b>	<b>French Door Decor Hardware System</b>
Minimum Shallow Mount	3/4"
Minimum Flush Inside Mount	2 3/8"
Minimum Outside Mount	3/4"
Minimum Side Mount	1 3/8"
<b>Recommended Side Mounting Method</b>	<ul style="list-style-type: none"> <li>• See page 20 for recommended mounting method for side mount shades</li> <li>• Width limit for side mount brackets is 48"</li> </ul>

<b>Finished Dimensions</b>	
<b>Inside and Side Mount</b>	
	<ul style="list-style-type: none"> <li>• Fabric will measure ordered width less: 3/8"</li> <li>• Head rail* will measure ordered width less: 3/16"</li> </ul>
<b>Outside Mount</b>	
	<ul style="list-style-type: none"> <li>• Fabric will measure ordered width</li> <li>• Head rail* will measure ordered width plus: 3/16"</li> </ul>
<b>Exact (End Cap to End Cap) Mount</b>	
	<ul style="list-style-type: none"> <li>• Fabric will measure ordered width less: 3/16"</li> <li>• Head rail* will measure ordered width</li> </ul>
<p>* Head rail measurements include endcaps. Width and length measurements may vary +/- 1/8"</p>	



# Color Lux® Cellular Specialty Shades

## FRENCH DOOR DÉCOR HARDWARE SYSTEM

### Applications

- Stationary Door Décor
- Movable Door Décor
- Top Down - Bottom Up Door Décor
- Cover French doors, transoms, and side lights.

### French Door Décor Hardware Features

- Features two non-moving rails which are mounted in the window or door. A tension control system enables the movable rail to be easily moved with the touch of a finger. The only visible cords are the ones that hold the movable middle rail in place.
- The widest width of the window cannot exceed the narrowest width of the window by more than  $\frac{3}{8}$ ".

### Stationary Non-Movable French Door Décor Shades

- Top and bottom rails are mounted to the window and are stationary.

### Movable French Door Décor Shades

- Top and bottom rails are mounted to the window, one middle movable rail raises from the bottom.

### Top Down - Bottom Up Option

- Top and bottom rails are mounted to the window, two movable rails allow the shade to lower from the top and raise from the bottom.
- The non-movable top and bottom rails are attached to the window or door.
- Ideal for entry ways with narrow windows next to doors and other narrow windows that are easily accessible.

### Ordering Information for French Door Décor

- Specify IB or OB mount and rail color.
- Specify stationary, movable or Top Down - Bottom Up.

### Accessories

- 6' Expandable Pole:
- 12' Expandable Pole:

Specially designed pole end allows for easy operation of French Door Décor Shades.

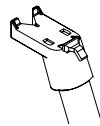

### French Door Decor Cellular Shades Hardware

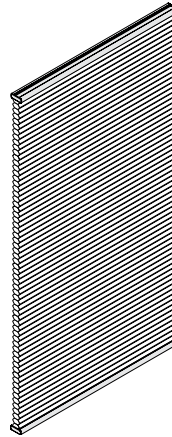

Stationary Non-Movable

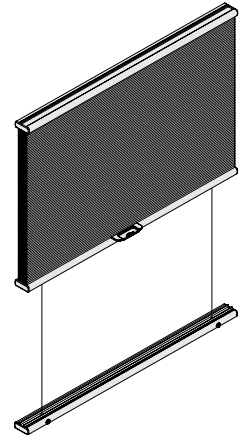

Shown open with movable rail option

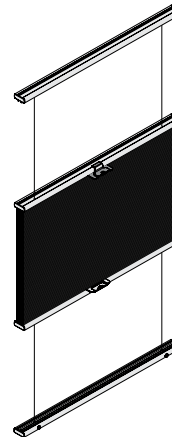

Shown open with Top Down - Bottom Up Option

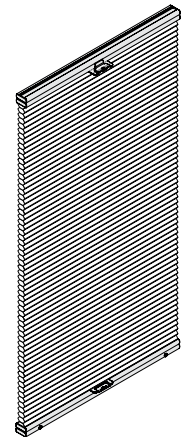

Shown closed with Top Down - Bottom Up Option



# Color Lux® Cellular Specialty Shades

## DAY-NIGHT SHADES HARDWARE SYSTEM



**Deluxe Head Rail**

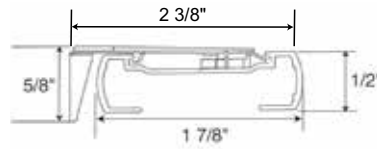

**Deluxe Rail**

- Depth of rail: 1 7/8"
- Depth of rail and bracket: 2 3/8"
- Height: 1 1/2"
- Height of bracket: 5/8"

**Hardware Features**

Fabric Wrapped Upgrade	Fabric used is same fabric as the shade. Back of rail is white to outside. Frosted clear end caps with fabric insert.
Designer Metallic Upgrade	<ul style="list-style-type: none"> <li>• Oil Rubbed Bronze head and bottom rails with bronze colored tassel, end caps and white cord.</li> <li>• Brushed Nickel head and bottom rails and end caps with coordinating tassel and white cord.</li> </ul>

Mounting Dimensions	Standard Cord Lock Rail
Minimum Shallow Mount	3/4"
Minimum Flush Inside Mount	2 3/8"
Minimum Outside Mount	3/4"
Minimum Side Mount	1 1/8"
<b>Recommended Side Mounting Method</b>	<ul style="list-style-type: none"> <li>• See page 20 for recommended mounting method for side mount shades</li> <li>• Width limit for side mount brackets is 48"</li> </ul>

**Finished Dimensions**

Inside and Side Mount	
	<ul style="list-style-type: none"> <li>• Fabric will measure ordered width less: 3/8"</li> <li>• Head rail* will measure ordered width less: 3/16"</li> </ul>
Outside Mount	
	<ul style="list-style-type: none"> <li>• Fabric will measure ordered width</li> <li>• Head rail* will measure ordered width plus: 3/16"</li> </ul>
Exact (End Cap to End Cap) Mount	
	<ul style="list-style-type: none"> <li>• Fabric will measure ordered width less: 3/16"</li> <li>• Head rail* will measure ordered width</li> </ul>

\* Head rail measurements include endcaps.  
Width and length measurements may vary +/- 1/8"

**Applications**

- Standard Rectangular with cellular fabrics only.

**Day - Night Shade Specifications**

Refer to the appropriate fabric sections for proper pricing.

# Color Lux® Cellular Specialty Shades

## DAY-NIGHT SHADES HARDWARE SYSTEM

### Rail Colors and Cord Colors

- **Color Coordinated Rail Shades:** The top rail and middle rail will coordinate with top fabric and bottom rail will coordinate with the bottom fabric. The cord and tassel will be white. Not available with Color Lux Shades.
- **Designer Metallic Hardware Shades:** All rails, end caps and tassels will be the selected metallic color. Cords will be white.
- **Fabric Wrapped Rail Shades:** The top rail and middle rail will coordinate with top fabric and bottom rail will coordinate with the bottom fabric. The cord and tassel will be white. End caps and cord lock will be color coordinated.

### Hardware Options

- Cord Lock

### Ordering Information for Day - Night Shade

- Specify fabrics, top and bottom panels.
- Specify IB or OB mount and rail color.

#### TOP FABRIC

CELLULAR	Width		Length	
	Min	Max	Min	Max
NEW Verona	12"	72"	18"	96"
NEW Boutique	12"	72"	18"	96"
Baritone (all)*	12"	72"	18"	96"
Debut ½" Double Cell Light Filtering	12"	72"	18"	96"
Debut ¾" Single Cell Light Filtering	12"	72"	18"	96"
Color Lux Linen Weave Light Filtering*	12"	72"	18"	96"
Color Lux Linen Weave Room Darkening*	NA	NA	NA	NA
Linen Weave Light Filtering*	12"	72"	18"	96"
Linen Weave Room Darkening*	NA	NA	NA	NA
Premiere ¾" Single Cell Blackout	NA	NA	NA	NA
Premiere ¾" Single Cell Light Filtering	12"	72"	18"	96"

#### BOTTOM FABRIC

Width		Length	
Min	Max	Min	Max
12"	72"	18"	96"
12"	72"	18"	96"
12"	72"	18"	96"
12"	72"	18"	96"
12"	72"	18"	96"
12"	72"	18"	96"
12"	72"	18"	96"
12"	72"	18"	96"
12"	72"	18"	96"
12"	72"	18"	96"

\* Day-Night Shades can only be built in conjunction with other ¾" cellular fabrics. All Debut includes print patterns: Strie, Terazzo, Angel Hair, Strat, Florance, Blossom, Country Woven and Homespun.

## Color Lux® Cellular Shades HIGHLIGHTS CORNICE VALANCE



### Highlights Cornice Valances

Highlight any element of your home décor with the Highlights Cornice Valance upgrade.

This tailored, fabric wrapped 6-inch valance, available with seven returns sized from 1½" to 6", mounts over any product, either inside or outside the frame. The keystone option now allows for all Color Lux Roller fabrics to cover widths up to 216".

Highlights Valance without a keystone can be added to your cellular shade order or as a stand alone product. Highlights Valance orders with a keystone are a stand alone product only.

See page 88 for more information.



## Color Lux® Cellular Shades EZ LEVEL

EZ Level makes quick work of leveling without cords to cut or tuck into a rail. No special tools needed – just use a nickel, quarter or penny to adjust plug on the bottom rail.

EZ Level is standard on all Cellular and Pleated Shades with the following hardware systems:

- Standard and Deluxe Cord Lock
- Cordless Ultra
- Cord Loop
- SlumberShades
- Simplicity Motorized Systems

EZ Level is not available with Lift & Lock Cordless.

### How does EZ Level work?

- Slightly raise the bottom rail you want to level.
- Insert a coin or flat head screwdriver into the adjustment screw and turn it.
- Turn the adjustment screw clockwise or counter clockwise to make slight adjustments up or down. One quarter turn of the adjustment screw will move the bottom rail up or down ¼".
- Lower the rail to check the level and make further adjustments if necessary.









## COLOR LUX® ROLLER SHADES







COLORLUX® ROLLER SHADES

**COLOR LUX**<sup>®</sup>  
*Designer Cellular & Roller Shades*





	Key Features	Control Options	Hardware Color Options	Hardware Size (Depth x Height)	Roll Style
<b>Skyline Roller Only</b> 	<ul style="list-style-type: none"> <li>• Skyline System</li> <li>• Sturdy aluminum tube for durability</li> <li>• Perfect under top treatments</li> <li>• Cord loop length does not change while operating shade</li> </ul>	<ul style="list-style-type: none"> <li>• Cord Loop</li> <li>• Motorization</li> </ul>	<ul style="list-style-type: none"> <li>• White,</li> <li>• Vanilla,</li> <li>• Black,</li> <li>• Bronze and</li> <li>• Satin Nickel</li> </ul> <p>Clutch, Bracket Covers, Bead Chain and Tensioner</p>	<p>Standard                      2½" x 2¾"                      2¼" x 2⅞"</p>	<p>Standard</p> <p>Reverse</p>
<b>Designer Cassette with Fabric Insert Strip</b> 	<ul style="list-style-type: none"> <li>• Cassette head rail features a matching fabric insert</li> <li>• Hides the roller shade mechanism for a tailored appearance</li> </ul>	<ul style="list-style-type: none"> <li>• Cord Loop</li> <li>• Cordless</li> <li>• Motorization</li> </ul>	<ul style="list-style-type: none"> <li>• White</li> <li>• Ivory</li> <li>• Black</li> <li>• Satin Nickel</li> <li>• Oil Rubbed Bronze</li> </ul> <p>All with fabric insert strip</p>	<p>3¾" x 2⅞"</p>	<p>Standard</p>
<b>Designer Cassette with Fabric Wrap</b> 	<ul style="list-style-type: none"> <li>• Head rail is wrapped with matching shade fabric</li> <li>• Head rail is white, black or oil rubbed bronze beneath the fabric wrap</li> <li>• Hides the mechanism for a soft appearance from top to bottom</li> </ul>	<ul style="list-style-type: none"> <li>• Cord Loop</li> <li>• Cordless</li> <li>• Motorization</li> </ul>	<ul style="list-style-type: none"> <li>• White</li> <li>• Ivory</li> <li>• Black</li> <li>• Satin Nickel</li> <li>• Oil Rubbed Bronze</li> </ul> <p>All with fabric wrap</p>	<p>3¾" x 2⅞"</p>	<p>Standard</p>
<b>Designer Cassette with Metallic Finish</b> 	<ul style="list-style-type: none"> <li>• Smooth finish head rail hides the roller shade mechanism</li> <li>• High quality finish for a modern appearance</li> </ul>	<ul style="list-style-type: none"> <li>• Cord Loop</li> <li>• Cordless</li> <li>• Motorization</li> </ul>	<ul style="list-style-type: none"> <li>• White</li> <li>• Ivory</li> <li>• Black</li> <li>• Satin Nickel</li> <li>• Oil Rubbed Bronze</li> </ul>	<p>3¾" x 2⅞"</p>	<p>Standard</p>
<b>Cordless with Deco-Bar</b> 	<ul style="list-style-type: none"> <li>• Cord-free system</li> <li>• Operates like a spring roller shade with a gentle pull on the bottom rail to raise and lower the shade</li> <li>• Smooth and quiet operation</li> <li>• Ideal from homes with children and pets</li> <li>• Clear handle included to ensure clean bottom rail</li> </ul>	<ul style="list-style-type: none"> <li>• Cordless</li> </ul>	<ul style="list-style-type: none"> <li>• White</li> <li>• Black</li> <li>• Ivory</li> <li>• Satin Nickel</li> <li>• Bronze</li> </ul> <p>Color Coordinated Bracket Covers</p>	<p>Shades to 72"                      (varies by fabric)                      1½" x 2¼"</p> <p>Over 72"                      (varies by fabric)                      1¾" x 2¾"</p>	<p>Standard</p> <p>Reverse</p>
<b>PowerTouch Rechargeable</b> 	<ul style="list-style-type: none"> <li>• Raise &amp; lower shading with the push of a button</li> <li>• Eliminate the need to stand by the shading to operate; just touch and go</li> <li>• Favorite position button</li> <li>• Rechargeable battery with recharge port on pendant</li> <li>• Features a favorite position</li> </ul>	<ul style="list-style-type: none"> <li>• Simplicity</li> </ul>	<ul style="list-style-type: none"> <li>• Skyline Roller</li> <li>• Designer Cassette (All)</li> <li>• Wand and Pendant available in white or black</li> </ul>	<p>Designer Cassette:                      3¾" x 2⅞"</p> <p>No Head Rail:                      Varies by shade size</p>	<p>Standard</p> <p>Reverse with Standard Roller</p>

**Color Lux® Roller Shades**  
**HARDWARE OPTIONS**

	Key Features	Control Options	Hardware Color Options	Hardware Size (Depth x Height)	Roll Style
<b>Simplicity Rechargeable Motorization</b> 	<ul style="list-style-type: none"> <li>Rechargeable motor is fully integrated within the roller tube</li> <li>No additional battery wand needs to be installed</li> <li>Battery lasts 6 to 12 months between charges (varies by size and usage)</li> </ul>	<ul style="list-style-type: none"> <li>Simplicity</li> </ul>	<ul style="list-style-type: none"> <li>Standard Roller</li> <li>Designer Cassette (All)</li> </ul>	Minimum Shade Width is 18"  Max size varies by fabric	Standard  Reverse with Standard Roller
<b>4" Skyline Fascia</b> 	<ul style="list-style-type: none"> <li>Conceals the Skyline Roller hardware system</li> <li>Cornice look</li> <li>Cord Loop and Motorization</li> <li>Fascia coordinates with all Skyline colors</li> </ul>	<ul style="list-style-type: none"> <li>Cord Loop</li> <li>Motorization</li> </ul>	<ul style="list-style-type: none"> <li>Black</li> <li>Brushed Nickel</li> <li>Vanilla</li> <li>Bronze</li> <li>White</li> </ul>	4" x 4"	Standard
<b>Simplicity Wave for Roller Shades</b> 	<ul style="list-style-type: none"> <li>Rechargeable motor is fully integrated within the roller tube</li> <li>Motor is operated via a separate wand that operates the shade with a touch of the head rail.</li> <li>Easy operation for hard to reach places</li> </ul>	<ul style="list-style-type: none"> <li>Simplicity</li> </ul>	<ul style="list-style-type: none"> <li>Designer Cassette (All)</li> </ul> See above for color options	Minimum Shade Width is 18"  Max size varies by fabric	Standard
<b>Designer Cassette with Retractable Cord</b> 	<ul style="list-style-type: none"> <li>Cords are white or black and coordinate with the clutch selected</li> <li>Smooth and simple operation</li> <li>Does not require a cord tensioner</li> <li>Ideal for out of reach shades</li> </ul>	<ul style="list-style-type: none"> <li>White or Black Retractable Cord</li> <li>Left or Right hand control</li> </ul>	<ul style="list-style-type: none"> <li>White</li> <li>Ivory</li> <li>Black</li> <li>Satin Nickel</li> <li>Oil Rubbed Bronze</li> </ul>	3¾" x 2⅞"	Standard

COLORLUX® ROLLER SHADES

**COLOR LUX ROLLER DECORATIVE OPTIONS**

<b>Highlights Cornice Valances</b> 	<ul style="list-style-type: none"> <li>Keystone for widths up to 216". Available in all Color Lux Roller Fabrics</li> <li>Coordinate all your shades and décor for a unified look</li> <li>Hide any roller hardware mechanism</li> </ul>	<ul style="list-style-type: none"> <li>Available as inside and outside mount</li> <li>Seven return options to fit any window</li> </ul>	<ul style="list-style-type: none"> <li>Fabric Wrapped</li> </ul>	<b>Width:</b> 24" to 216" (includes returns) <b>Height:</b> 6" <b>Returns:</b> 1½" to 6"	NA
<b>Bottom Rails</b> 	<ul style="list-style-type: none"> <li>Add an a decorative accent to bottom of your shade or fabric wrap the bottom rail for a soft look.</li> <li>Two clear plastic end caps secure the fabric in place.</li> </ul>	All hardware	<ul style="list-style-type: none"> <li>White</li> <li>Black</li> <li>Bronze</li> <li>Aluminum</li> <li>Vanilla</li> </ul> For fabric wrap, rail colors are street side only	NA	NA
<b>Reverse Roll</b> 	<ul style="list-style-type: none"> <li>The fabric rolls from the front of the roller, concealing the hardware.</li> </ul>	<ul style="list-style-type: none"> <li>Standard Roller</li> <li>Cordless Deco-Bar</li> <li>Standard Roller with Motorization</li> </ul>	See page 72 for color options for your hardware selection	See page 67 & 69 for hardware size	NA
<b>Standard Roll</b> 	<ul style="list-style-type: none"> <li>Fabric rolls off the back of the roller</li> </ul>	<ul style="list-style-type: none"> <li>Standard Roller</li> <li>Cordless Deco-Bar</li> <li>Motorization</li> </ul>	See page 72 for color options for your hardware selection	See page 67 & 69 for hardware size	NA



# Color Lux® Roller Shades

## SKYLINE HARDWARE OPTIONS

Color Lux provides beautiful color coordination for various hardware options to provide ultimate roller shade design and quality. White, Ivory and Black Skyline hardware is standard on all Color Lux Roller shades. All components are color coordinated, including clutch, bracket covers, bead chain and the tensioner. See individual price grids for pricing.

### Skyline Hardware in White



Designer Cassette with Skyline Hardware



Standard Roller with Skyline Hardware



4" Skyline Fascia

Clutch, Cassette, Bead Chain, Brackets, Bracket Covers and Tensioner are in White

### Skyline Hardware in Ivory



Designer Cassette with Skyline Hardware



Standard Roller with Skyline Hardware



4" Skyline Fascia

Clutch, Cassette, Bead Chain, Brackets, Bracket Covers and Tensioner are in Ivory

### Skyline Hardware in Black



Designer Cassette with Skyline Hardware



Standard Roller with Skyline Hardware



4" Skyline Fascia

Clutch, Cassette, Bead Chain, Brackets, Bracket Covers and Tensioner are in Black



# Color Lux® Roller Shades

## SKYLINE HARDWARE OPTIONS

### Skyline Hardware in Satin Nickel



Designer Cassette with Skyline Hardware



Standard Roller with Skyline Hardware

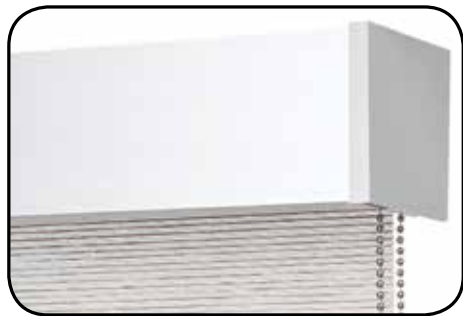

4" Skyline Fascia

Clutch, Cassette, Bead Chain, Bracket, Bracket Covers and Tensioner are in Satin Nickel.

### Skyline Hardware in Bronze



Designer Cassette with Skyline Hardware



Standard Roller with Skyline Hardware



4" Skyline Fascia

Clutch, Cassette, Bead Chain, Brackets, Bracket Covers and Tensioner are in Bronze

### Dual Roller Shades



Black and White Brackets



Mix and Match Light Filtering and Blackout Fabrics

Dual Roller Shades are available with Remote Motorization and Cord Loop Control

**FABRIC INFORMATION**

**Choosing the Right Color Lux Roller Fabric**

**What are the fabric contents of each fabric?**

- Classic Duck Light Filtering is 100% Polyester
- Classic Duck Blackout is 100% Polyester
- Linen Light Filtering is 100% Polyester
- Linen Blackout is 100% Polyester with a foam coated backing
- Solar Screen 5 is 36% Polyester, 51% FR Polyester and 13% Cationic Polyester

**Classic Duck Light Filtering and Blackout Fabrics**

Classic Duck provides the perfect canvas for all 800 Color Lux colors. A simple weave works well with any complementary fabric textures. Available in Light Filtering and Blackout.

**Linen Light Filtering and Blackout Fabrics**

Linen provides the natural timeless look of linen fabric into Color Lux Roller Shades. Light Filtering allows in just the right amount of opacity to maintain privacy but allow light into the home. Linen Blackout is perfect for bedroom and media room applications.

**Solar Screen 5 Fabric**

Solar Screen 5 is the perfect balance of function and design. With a 5% openness factor, Solar Screen 5 provides light and privacy. Color Lux Color 100 Ultra White has passed the NFPA and California Title 19 Fire Rating Standards. Solar Screen 5 also offers a subtle linen texture that enhances every decor style.

**What are the fabric properties of Solar Screen 5?**

The below ratings apply to **Color Lux Color 100 Ultra White Only**

	TS	RS	AS	TV	OF	SHGC/G Value		Fire Rating
						Commercial SHGC % Improvement	Residential SHGC	
<b>Solar Screen 5</b>								
100 Ultra White*	39	56	5	38	5.00	39%	0.42	NFPA 701-10 TM#1, California U.S. Title 19
<b>ISO 14001:2004</b>								
<b>OEKO-TEX® Standard 100</b>								
<b>OEKO-TEX® Standard 1000</b>								
<b>Zero Landfill</b>								
<b>Water Conservation and Usage</b>								
<b>Use of Recycled Materials</b>								

\* Fire Rating and other properties apply to Ultra White (Color Lux Color 100) only

To be certified with OEKO-TEX® Standard 100, companies hve to meet defined criteria regarding their environmentally friendly and socially acceptable production process at all production stages (International Association for Reseach and Testing in the Field of Textile Ecology)

- TS = Solar Transmittance
- RS = Solar Reflectance
- AS = Solar Absorptance
- TV = Visual Transmittance
- OF= Openness Factor
- 1/4 CL = 1/4" Clear Glass
- 1/4 HA = 1/4" Heat Absorbing Glass

COLORLUX® ROLLER SHADES

Skyline Standard Roller Shade

Price Group 17 | Classic Duck Light Filtering

		Width In Inches																				
		24	30	36	42	48	54	60	66	72	78	84	90	96	102	106	112	118	124	130	136	144
Length In Inches	36	228	253	281	312	347	384	427	481	534	599	682	751	809	874	943	964	1148	1253	1367	1495	1631
	42	233	260	288	321	356	395	438	495	550	615	699	769	830	898	969	988	1179	1286	1407	1533	1677
	48	241	267	297	330	366	407	449	507	564	631	718	790	853	921	995	1014	1210	1320	1442	1575	1718
	54	249	273	303	337	374	414	462	520	578	646	737	809	876	946	1021	1042	1241	1355	1478	1615	1764
	60	253	281	312	346	384	426	473	534	594	664	754	829	896	967	1044	1065	1271	1388	1517	1654	1784
	66	260	287	320	354	394	437	484	545	606	679	771	851	917	991	1071	1094	1303	1422	1552	1696	1808
	72	265	296	326	365	403	446	496	560	622	696	792	869	941	1014	1098	1118	1334	1457	1588	1737	1835
	78	272	301	336	371	411	457	507	573	635	714	809	889	961	1039	1120	1145	1365	1489	1626	1744	1993
	84	278	308	341	378	421	469	520	584	651	728	828	912	984	1063	1146	1170	1395	1524	1570	1749	2053
	90	285	315	350	388	431	478	530	599	665	745	845	930	1006	1105	1183	1196	1426	1558	1605	1764	2115
	96	290	322	357	399	441	488	541	613	677	760	865	952	1027	1152	1212	1222	1458	1591	1639	1967	2179
	102	300	333	368	409	453	504	560	631	701	777	884	972	1049	1182	1237	1258	1502	1639	1831	2026	2244
	108	305	339	377	416	464	514	570	643	716	793	901	991	1071	1189	1277	1296	1547	1688	1886	2087	2311
	114	311	345	382	425	473	525	582	657	730	809	921	1011	1095	1217	1314						
120	318	353	392	435	483	535	594	670	745	825	938	1033	1115	1237	1363							
126	324	360	400	445	491	546	605	683	759	842	957	1052	1140	1265	1381							
132	333	368	409	453	502	559	618	697	774	859	976	1073	1161	1290	1458							
138	339	375	415	462	511	569	630	710	790	876	995	1096	1183	1310	1484							
144	345	381	423	472	521	580	642	725	805	891	1014	1117	1209	1362	1524							

Classic Duck Light Filtering: Minimum standard shade size is 12" x 12". Maximum shade width is 106" and it can be railroaded to a maximum width of 144" and a maximum length of 108".

Head Rail Options and Surcharges

Section 1 & 2	Available: Skyline Hardware (All), Designer Cassette (All), Cordless Deco-Bar, 4" Skyline Fascia, Motorization, PowerTouch Rechargeable
Section 3	Available: Skyline Roller Only with Cordloop, Heavy Duty Motorization (Roller Only), 4" Skyline Fascia with Cord Loop (Dual Roller Not Available)
Section 4	Available: Skyline Roller Only with Cordloop, and Heavy Duty Motorization (Roller Only) (Dual Roller Not Available)

Roller Only Options

Skyline Clutch (White, Ivory, Black)	No Additional Surcharge
Skyline Clutch (Satin Nickel and Bronze)	\$28
Skyline Dual Roller (Price two separate shades, then add surcharge)	\$28
Cordless with White, Ivory and Black Deco-Bar	\$42
Cordless with Bronze and Satin Nickel Deco-Bar	\$63
Spring Assist for Shades over 84" x 84" (White or Black Clutch)	\$130

Designer Cassette and Fascia Options

	24	30	36	42	48	54	60	66	72	78	84	90	96	102	108	114	120
White, Ivory, Black, Satin Nickel, and Oil Rubbed Bronze Includes Smooth Face, Insert Strip and Fabric Wrap	78	84	90	97	103	111	119	126	133	128	135	147	152	156	162	185	208
4" Skyline Fascia	64	70	72	74	84	97	106	117	128	137	149	162	169	179	191	201	210
Cordless with Cassette	Add \$42 PLUS the Designer Cassette Surcharge																
Retractable Cord with Designer Cassette	Add \$42 PLUS the Designer Cassette Surcharge																

Highlights Cornice Valance

	24	30	36	42	48	54	60	66	72	78	84	94	102	106	112	118	124	130	136	144
Highlights Cornice Valance (No Keystone)	96	106	116	125	137	143	150	158	164	170	177	189	Requires Keystone. See pricing below							
Highlights Cornice Valance (with Keystone)	128	139	149	158	169	175	183	190	196	203	210	222	238	246	254	264	272	282	292	302

Motorization: Available with Designer Cassette, 4" Skyline Fascia, and Standard Roller

Add Motorization surcharges to base shade price, plus desired hardware options		Reference
PowerTouch Rechargeable	\$118 per shade	pg. 83
Simplicity Wave	\$121 per shade	pg. 80
Simplicity Rechargeable Motorization	\$319 per shade	pg. 85
Simplicity Rechargeable Heavy Duty Motorization	\$434 per shade	pg. 86
Simplicity 5 Channel Remote	\$41 per remote	pg. 87
Simplicity 6 Channel Timer Remote	\$67 per remote	pg. 87
Simplicity 14 Channel Remote	\$67 per remote	pg. 87
Simplicity Smart Controller	\$336 per controller	pg. 30
Solar Panel	\$105 per panel	pg. 86
Telescoping Wand for Simplicity Wave	\$32 per wand	pg. 80
Charger for Simplicity Rechargeable Motor	\$28 per charger	pg. 85
Charger for Heavy Duty Rechargeable Motor	\$59 per charger	pg. 86

**Cordless Specifications:**  
 Minimum width is 15½";  
 Maximum Width is 96";  
 Maximum Length is 96"

Tube Information for Clutch Operated Shades Only

- **Section 1:** Shades to the left of the dashed line requires a 1" tube/SL10" clutch
- **Section 2:** Shades to the right of the dashed line requires a 1½" tube/SL10 clutch
- **Section 3:** Shades in the blue section requires a 2" tube/SL20 clutch.
- **Section 4:** Shades in the orange section requires a 2½" tube/ Galaxy 200 clutch

Skyline Standard Roller Shade

Price Group 18 | Classic Duck Blackout

Width In Inches

	24	30	36	42	48	54	60	66	72	78	84	90	96	102	106	112	118	124	130	136	144
36	253	281	312	346	385	427	474	534	594	666	756	834	897	970	1046	1070	1274	1392	1519	1660	1809
42	259	288	320	356	396	439	487	550	610	684	776	854	922	997	1075	1098	1309	1427	1562	1701	1862
48	267	296	331	366	406	452	499	563	626	701	796	876	947	1023	1105	1127	1342	1466	1601	1747	1909
54	277	303	336	374	416	461	512	577	641	718	819	897	973	1050	1133	1159	1378	1504	1641	1792	2035
60	281	312	346	384	427	473	525	594	659	737	837	920	994	1073	1160	1182	1411	1541	1683	1836	2170
66	288	319	355	394	437	484	538	605	673	755	857	944	1018	1100	1189	1213	1449	1578	1722	1957	2313
72	295	330	364	405	446	496	551	621	690	771	880	964	1043	1127	1219	1240	1480	1617	1763	2087	2466
78	302	334	373	411	457	507	563	637	706	792	897	987	1067	1152	1243	1271	1516	1654	1880	2225	2629
84	308	342	378	420	467	520	577	649	722	808	919	1012	1094	1178	1272	1299	1549	1691	2004	2371	2802
90	317	350	388	431	478	531	588	665	739	826	938	1033	1116	1227	1315	1328	1585	1802	2137	2527	2987
96	322	357	398	442	490	541	600	679	752	843	960	1057	1141	1280	1346	1356	1619	1921	2278	2694	3184
102	334	369	409	454	503	560	622	701	779	872	1000	1103	1246	1404	1469	1547	1847	2191	2599	3073	3633
108	338	377	417	462	515	570	633	715	794	942	1072	1177	1272	1412	1517	1649	1969	2336	2771	3276	3873
114	346	382	424	472	525	582	646	729	810	897	1023	1121	1214	1351	1457						
120	353	392	435	483	536	594	659	745	826	916	1041	1146	1238	1373	1513						
126	360	400	444	494	545	606	671	758	842	935	1063	1168	1265	1404	1532						
132	369	409	454	503	557	620	686	773	859	953	1083	1192	1288	1432	1563						
138	377	415	461	513	568	632	700	790	876	973	1105	1216	1315	1454	1594						
144	382	423	470	524	579	644	714	805	893	990	1127	1240	1342	1512	1626						

**Classic Duck Blackout:** Minimum standard shade size is 12" x 12". Maximum shade width is 106" and it can be railroaded to a maximum width of 144" and a maximum length of 108"

Head Rail Options and Surcharges

Section 1 & 2	Available: Skyline Hardware (All), Designer Cassette (All), Cordless Deco-Bar, 4" Skyline Fascia, Motorization, PowerTouch Rechargeable
Section 3	Available: Skyline Roller Only with Cordloop, Heavy Duty Motorization (Roller Only), 4" Skyline Fascia with Cord Loop (Dual Roller Not Available)
Section 4	Available: Skyline Roller Only with Cordloop, and Heavy Duty Motorization (Roller Only) (Dual Roller Not Available)

Roller Only Options

Skyline Clutch (White, Ivory, Black)	No Additional Surcharge
Skyline Clutch (Satin Nickel and Bronze)	\$28
Skyline Dual Roller (Price two separate shades, then add surcharge)	\$28
Cordless with White, Ivory and Black Deco-Bar	\$42
Cordless with Bronze and Satin Nickel Deco-Bar	\$63
Spring Assist for Shades over 84" x 84" (White or Black Clutch)	\$130

Designer Cassette and Fascia Options

	24	30	36	42	48	54	60	66	72	78	84	90	96	102	108	114	120
White, Ivory, Black, Satin Nickel, and Oil Rubbed Bronze Includes Smooth Face, Insert Strip and Fabric Wrap	78	84	90	97	103	111	119	126	133	128	135	147	152	156	162	185	208
4" Skyline Fascia	64	70	72	74	84	97	106	117	128	137	149	162	169	179	191	201	210
Cordless with Cassette	Add \$42 PLUS the Designer Cassette Surcharge																
Retractable Cord with Designer Cassette	Add \$42 PLUS the Designer Cassette Surcharge																

Highlights Cornice Valance

	24	30	36	42	48	54	60	66	72	78	84	94	102	106	112	118	124	130	136	144
Highlights Cornice Valance (No Keystone)	96	106	116	125	137	143	150	158	164	170	177	189	Requires Keystone. See pricing below							
Highlights Cornice Valance (with Keystone)	128	139	149	158	169	175	183	190	196	203	210	222	238	246	254	264	272	282	292	302

Motorization: Available with Designer Cassette, 4" Skyline Fascia, and Standard Roller

Add Motorization surcharges to base shade price, plus desired hardware options	Reference
PowerTouch Rechargeable	\$118 per shade pg. 83
Simplicity Wave	\$121 per shade pg. 80
Simplicity Rechargeable Motorization	\$319 per shade pg. 85
Simplicity Rechargeable Heavy Duty Motorization	\$434 per shade pg. 86
Simplicity 5 Channel Remote	\$41 per remote pg. 87
Simplicity 6 Channel Timer Remote	\$67 per remote pg. 87
Simplicity 14 Channel Remote	\$67 per remote pg. 87
Simplicity Smart Controller	\$336 per controller pg. 30
Solar Panel	\$105 per panel pg. 86
Telescoping Wand for Simplicity Wave	\$32 per wand pg. 80
Charger for Simplicity Rechargeable Motor	\$28 per charger pg. 85
Charger for Heavy Duty Rechargeable Motor	\$59 per charger pg. 86

**Cordless Specifications:**

Minimum width is 15½";  
Maximum Width is 96";  
Maximum Length is 96"

**Tube Information for Clutch Operated Shades Only**

- **Section 1:** Shades to the left of the dashed line requires a 1" tube/SL10" clutch
- **Section 2:** Shades to the right of the dashed line requires a 1½" tube/SL10 clutch
- **Section 3:** Shades in the blue section requires a 2" tube/SL20 clutch.
- **Section 4:** Shades in the orange section requires a 2½" tube/ Galaxy 200 clutch

Skyline Standard Roller Shade

Price Group 19 | Linen Light Filtering

		Width In Inches																				
		24	30	36	42	48	54	60	66	72	78	84	90	96	102	106	112	118	124	130	136	144
Length In Inches	36	228	253	281	312	347	384	427	481	534	599	682	751	809	874	943	964	1148	1253	1367	1495	1631
	42	233	260	288	321	356	395	438	495	550	615	699	769	830	898	969	988	1179	1286	1407	1533	1677
	48	241	267	297	330	366	407	449	507	564	631	718	790	853	921	995	1014	1210	1320	1442	1575	1718
	54	249	273	303	337	374	414	462	520	578	646	737	809	876	946	1021	1042	1241	1355	1478	1615	1764
	60	253	281	312	346	384	426	473	534	594	664	754	829	896	967	1044	1065	1271	1388	1517	1654	1784
	66	260	287	320	354	394	437	484	545	606	679	771	851	917	991	1071	1094	1303	1422	1552	1696	1808
	72	265	296	326	365	403	446	496	560	622	696	792	869	941	1014	1098	1118	1334	1457	1588	1737	1835
	78	272	301	336	371	411	457	507	573	635	714	809	889	961	1039	1120	1145	1365	1489	1626	1744	1993
	84	278	308	341	378	421	469	520	584	651	728	828	912	984	1063	1146	1170	1395	1524	1570	1749	2053
	90	285	315	350	388	431	478	530	599	665	745	845	930	1006	1105	1183	1196	1426	1558	1605	1764	2115
	96	290	322	357	399	441	488	541	613	677	760	865	952	1027	1152	1212	1222	1458	1591	1639	1967	2179
	102	300	333	368	409	453	504	560	631	701	777	884	972	1049	1182	1237	1258	1502	1639	1831	2026	2244
	108	305	339	377	416	464	514	570	643	716	793	901	991	1071	1189	1277	1296	1547	1688	1886	2087	2311
	114	311	345	382	425	473	525	582	657	730	809	921	1011	1095	1217	1314						
120	318	353	392	435	483	535	594	670	745	825	938	1033	1115	1237	1363							
126	324	360	400	445	491	546	605	683	759	842	957	1052	1140	1265	1381							
132	333	368	409	453	502	559	618	697	774	859	976	1073	1161	1290	1458							
138	339	375	415	462	511	569	630	710	790	876	995	1096	1183	1310	1484							
144	345	381	423	472	521	580	642	725	805	891	1014	1117	1209	1362								

Color Lux Linen Light Filtering: Minimum standard shade size is 12" x 12". Maximum shade width is 106" and it can be railroaded to a maximum width of 144" and a maximum length of 108".

Head Rail Options and Surcharges

Section 1 & 2	Available: Skyline Hardware (All), Designer Cassette (All), Cordless Deco-Bar, 4" Skyline Fascia, Motorization, PowerTouch Rechargeable
Section 3	Available: Skyline Roller Only with Cordloop, Heavy Duty Motorization (Roller Only), 4" Skyline Fascia with Cord Loop (Dual Roller Not Available)
Section 4	Available: Skyline Roller Only with Cordloop, and Heavy Duty Motorization (Roller Only) (Dual Roller Not Available)

Roller Only Options

Skyline Clutch (White, Ivory, Black)	No Additional Surcharge
Skyline Clutch (Satin Nickel and Bronze)	\$28
Skyline Dual Roller (Price two separate shades, then add surcharge)	\$28
Cordless with White, Ivory and Black Deco-Bar	\$42
Cordless with Bronze and Satin Nickel Deco-Bar	\$63
Spring Assist for Shades over 84" x 84" (White or Black Clutch)	\$130

Designer Cassette and Fascia Options

	24	30	36	42	48	54	60	66	72	78	84	90	96	102	108	114	120
White, Ivory, Black, Satin Nickel, and Oil Rubbed Bronze Includes Smooth Face, Insert Strip and Fabric Wrap	78	84	90	97	103	111	119	126	133	128	135	147	152	156	162	185	208
4" Skyline Fascia	64	70	72	74	84	97	106	117	128	137	149	162	169	179	191	201	210
Cordless with Cassette	Add \$42 PLUS the Designer Cassette Surcharge																
Retractable Cord with Designer Cassette	Add \$42 PLUS the Designer Cassette Surcharge																

Highlights Cornice Valance

	24	30	36	42	48	54	60	66	72	78	84	94	102	106	112	118	124	130	136	144
Highlights Cornice Valance (No Keystone)	96	106	116	125	137	143	150	158	164	170	177	189	Requires Keystone. See pricing below							
Highlights Cornice Valance (with Keystone)	128	139	149	158	169	175	183	190	196	203	210	222	238	246	254	264	272	282	292	302

Motorization: Available with Designer Cassette, 4" Skyline Fascia, and Standard Roller

Add Motorization surcharges to base shade price, plus desired hardware options

	Reference
PowerTouch Rechargeable	\$118 per shade pg. 83
Simplicity Wave	\$121 per shade pg. 80
Simplicity Rechargeable Motorization	\$319 per shade pg. 85
Simplicity Rechargeable Heavy Duty Motorization	\$434 per shade pg. 86
Simplicity 5 Channel Remote	\$41 per remote pg. 87
Simplicity 6 Channel Timer Remote	\$67 per remote pg. 87
Simplicity 14 Channel Remote	\$67 per remote pg. 87
Simplicity Smart Controller	\$336 per controller pg. 30
Solar Panel	\$105 per panel pg. 86
Telescoping Wand for Simplicity Wave	\$32 per wand pg. 80
Charger for Simplicity Rechargeable Motor	\$28 per charger pg. 85
Charger for Heavy Duty Rechargeable Motor	\$59 per charger pg. 86

**Cordless Specifications:**  
 Minimum width is 15½";  
 Maximum Width is 96";  
 Maximum Length is 96"

Tube Information for Clutch Operated Shades Only

- **Section 1:** Shades to the left of the dashed line requires a 1" tube/SL10" clutch
- **Section 2:** Shades to the right of the dashed line requires a 1½" tube/SL10 clutch
- **Section 3:** Shades in the blue section requires a 2" tube/SL20 clutch.
- **Section 4:** Shades in the orange section requires a 2½" tube/Galaxy 200 clutch



Skyline Standard Roller Shade

Price Group 20 | Linen Blackout

		Width In Inches																					
		24	30	36	42	48	54	60	66	72	78	84	90	96	102	106	112	118	124	130	136	144	
Length In Inches	36	253	281	312	346	385	427	474	534	594	666	756	834	897	970	1046	1070	1274	1392	1519	1660	1809	
	42	259	288	320	356	396	439	487	550	610	684	776	854	922	997	1075	1098	1309	1427	1562	1701	1862	
	48	267	296	331	366	406	452	499	563	626	701	796	876	947	1023	1105	1127	1342	1466	1601	1747	1909	
	54	277	303	336	374	416	461	512	577	641	718	819	897	973	1050	1133	1159	1378	1504	1641	1792	2035	
	60	281	312	346	384	427	473	525	594	659	737	837	920	994	1073	1160	1182	1411	1541	1683	1836	2170	
	66	288	319	355	394	437	484	538	605	673	755	857	944	1018	1100	1189	1213	1449	1578	1722	1957	2313	
	72	295	330	364	405	446	496	551	621	690	771	880	964	1043	1127	1219	1240	1480	1617	1763	2087	2466	
	78	302	334	373	411	457	507	563	637	706	792	897	987	1067	1152	1243	1271	1516	1654	1880	2225	2629	
	84	308	342	378	420	467	520	577	649	722	808	919	1012	1094	1178	1272	1299	1549	1691	2004	2371	2802	
	90	317	350	388	431	478	531	588	665	739	826	938	1033	1116	1227	1315	1328	1585	1802	2137	2527	2987	
	96	322	357	398	442	490	541	600	679	752	843	960	1057	1141	1280	1346	1356	1619	1921	2278	2694	3184	
	102	334	369	409	454	503	560	622	701	779	872	1000	1100	1183	1246	1404	1469	1547	1847	2191	2599	3073	3633
	108	338	377	417	462	515	570	633	715	794	892	1022	1122	1205	1268	1426	1491	1649	1969	2336	2771	3276	3873
	114	346	382	424	472	525	582	646	729	810	897	1023	1121	1214	1351	1457							
120	353	392	435	483	536	594	659	745	826	916	1041	1146	1238	1373	1513								
126	360	400	444	494	545	606	671	758	842	935	1063	1168	1265	1404	1532								
132	369	409	454	503	557	620	686	773	859	953	1083	1192	1288	1432									
138	377	415	461	513	568	632	700	790	876	973	1105	1216	1315	1454									
144	382	423	470	524	579	644	714	805	893	990	1127	1240	1342	1512									

**Color Lux Linen Blackout:** Minimum standard shade size is 12" x 12". Maximum shade width is 106" and it can be railroaded to a maximum width of 144" and a maximum length of 108"

Head Rail Options and Surcharges

Section 1 & 2	Available: Skyline Hardware (All), Designer Cassette (All), Cordless Deco-Bar, 4" Skyline Fascia, Motorization, PowerTouch Rechargeable
Section 3	Available: Skyline Roller Only with Cordloop, Heavy Duty Motorization (Roller Only), 4" Skyline Fascia with Cord Loop (Dual Roller Not Available)
Section 4	Available: Skyline Roller Only with Cordloop, and Heavy Duty Motorization (Roller Only) (Dual Roller Not Available)

Roller Only Options

Skyline Clutch (White, Ivory, Black)	No Additional Surcharge
Skyline Clutch (Satin Nickel and Bronze)	\$28
Skyline Dual Roller (Price two separate shades, then add surcharge)	\$28
Cordless with White, Ivory and Black Deco-Bar	\$42
Cordless with Bronze and Satin Nickel Deco-Bar	\$63
Spring Assist for Shades over 84" x 84" (White or Black Clutch)	\$130

Designer Cassette and Fascia Options

	24	30	36	42	48	54	60	66	72	78	84	90	96	102	108	114	120
White, Ivory, Black, Satin Nickel, and Oil Rubbed Bronze Includes Smooth Face, Insert Strip and Fabric Wrap	78	84	90	97	103	111	119	126	133	128	135	147	152	156	162	185	208
4" Skyline Fascia	64	70	72	74	84	97	106	117	128	137	149	162	169	179	191	201	210
Cordless with Cassette	Add \$42 PLUS the Designer Cassette Surcharge																
Retractable Cord with Designer Cassette	Add \$42 PLUS the Designer Cassette Surcharge																

Highlights Cornice Valance

	24	30	36	42	48	54	60	66	72	78	84	94	102	106	112	118	124	130	136	144
Highlights Cornice Valance (No Keystone)	96	106	116	125	137	143	150	158	164	170	177	189	Requires Keystone. See pricing below							
Highlights Cornice Valance (with Keystone)	128	139	149	158	169	175	183	190	196	203	210	222	238	246	254	264	272	282	292	302

Motorization: Available with Designer Cassette, 4" Skyline Fascia, and Standard Roller

	Reference
PowerTouch Rechargeable	\$118 per shade pg. 83
Simplicity Wave	\$121 per shade pg. 80
Simplicity Rechargeable Motorization	\$319 per shade pg. 85
Simplicity Rechargeable Heavy Duty Motorization	\$434 per shade pg. 86
Simplicity 5 Channel Remote	\$41 per remote pg. 87
Simplicity 6 Channel Timer Remote	\$67 per remote pg. 87
Simplicity 14 Channel Remote	\$67 per remote pg. 87
Simplicity Smart Controller	\$336 per controller pg. 30
Solar Panel	\$105 per panel pg. 86
Telescoping Wand for Simplicity Wave	\$32 per wand pg. 80
Charger for Simplicity Rechargeable Motor	\$28 per charger pg. 85
Charger for Heavy Duty Rechargeable Motor	\$59 per charger pg. 86

**Cordless Specifications:**  
 Minimum width is 15½";  
 Maximum Width is 90";  
 Maximum Length is 84"

Tube Information for Clutch Operated Shades Only

- **Section 1:** Shades to the left of the dashed line requires a 1" tube/SL10" clutch
- **Section 2:** Shades to the right of the dashed line requires a 1½" tube/SL10 clutch
- **Section 3:** Shades in the blue section requires a 2" tube/SL20 clutch.
- **Section 4:** Shades in the orange section requires a 2½" tube/ Galaxy 200 clutch

Skyline Standard Roller Shade

Price Group 21 | Solar Screen 5

Length In Inches	Width In Inches																				
	24	30	36	42	48	54	60	66	72	78	84	90	96	102	106	112	118	124	130	136	144
36	228	253	281	312	347	384	427	481	534	599	682	751	809	874	943	964	1148	1253	1367	1495	1631
42	233	260	288	321	356	395	438	495	550	615	699	769	830	898	969	988	1179	1286	1407	1533	1677
48	241	267	297	330	366	407	449	507	564	631	718	790	853	921	995	1014	1210	1320	1442	1575	1718
54	249	273	303	337	374	414	462	520	578	646	737	809	876	946	1021	1042	1241	1355	1478	1615	1764
60	253	281	312	346	384	426	473	534	594	664	754	829	896	967	1044	1065	1271	1388	1517	1654	1784
66	260	287	320	354	394	437	484	545	606	679	771	851	917	991	1071	1094	1303	1422	1552	1696	1808
72	265	296	326	365	403	446	496	560	622	696	792	869	941	1014	1098	1118	1334	1457	1588	1737	1835
78	272	301	336	371	411	457	507	573	635	714	809	889	961	1039	1120	1145	1365	1489	1626	1744	1993
84	278	308	341	378	421	469	520	584	651	728	828	912	984	1063	1146	1170	1395	1524	1670	1749	2053
90	285	315	350	388	431	478	530	599	665	745	845	930	1006	1105	1183	1196	1426	1558	1605	1764	2115
96	290	322	357	399	441	488	541	613	677	760	865	952	1027	1152	1212	1222	1458	1591	1639	1967	2179
102	300	333	368	409	453	504	560	631	701	777	884	972	1049	1182	1237	1258	1502	1639	1831	2026	2244
108	305	339	377	416	464	514	570	643	716	793	901	991	1071	1189	1277	1296	1547	1688	1886	2087	2311
114	311	345	382	425	473	525	582	657	730	809	921	1011	1095	1217	1314						
120	318	353	392	435	483	535	594	670	745	825	938	1033	1115	1237	1363						
126	324	360	400	445	491	546	605	683	759	842	957	1052	1140	1265	1381						
132	333	368	409	453	502	559	618	697	774	859	976	1073	1161	1290	1458						
138	339	375	415	462	511	569	630	710	790	876	995	1096	1183	1310	1484						
144	345	381	423	472	521	580	642	725	805	891	1014	1117	1209	1362	1524						

Solar Screen 5: Minimum standard shade size is 12" x 12". Maximum shade width is 114" and it can be railroaded to a maximum width of 144" and a maximum length of 108".

Head Rail Options and Surcharges

Section 1 & 2	Available: Skyline Hardware (All), Designer Cassette (All), Cordless Deco-Bar, 4" Skyline Fascia, Motorization, PowerTouch Rechargeable
Section 3	Available: Skyline Roller Only with Cordloop, Heavy Duty Motorization (Roller Only), 4" Skyline Fascia with Cord Loop (Dual Roller Not Available)
Section 4	Available: Skyline Roller Only with Cordloop, and Heavy Duty Motorization (Roller Only) (Dual Roller Not Available)

Roller Only Options

Skyline Clutch (White, Ivory, Black)	No Additional Surcharge
Skyline Clutch (Satin Nickel and Bronze)	\$28
Skyline Dual Roller (Price two separate shades, then add surcharge)	\$28
Cordless with White, Ivory and Black Deco-Bar	\$42
Cordless with Bronze and Satin Nickel Deco-Bar	\$63
Spring Assist for Shades over 84" x 84" (White or Black Clutch)	\$130

Designer Cassette and Fascia Options

	24	30	36	42	48	54	60	66	72	78	84	90	96	102	108	114	120
White, Ivory, Black, Satin Nickel, and Oil Rubbed Bronze Includes Smooth Face, Insert Strip and Fabric Wrap	78	84	90	97	103	111	119	126	133	128	135	147	152	156	162	185	208
4" Skyline Fascia	64	70	72	74	84	97	106	117	128	137	149	162	169	179	191	201	210
Cordless with Cassette	Add \$42 PLUS the Designer Cassette Surcharge																
Retractable Cord with Designer Cassette	Add \$42 PLUS the Designer Cassette Surcharge																

Highlights Cornice Valance

	24	30	36	42	48	54	60	66	72	78	84	94	102	106	112	118	124	130	136	144
Highlights Cornice Valance (No Keystone)	96	106	116	125	137	143	150	158	164	170	177	189	Requires Keystone. See pricing below							
Highlights Cornice Valance (with Keystone)	128	139	149	158	169	175	183	190	196	203	210	222	238	246	254	264	272	282	292	302

Motorization: Available with Designer Cassette, 4" Skyline Fascia, and Standard Roller

Add Motorization surcharges to base shade price, plus desired hardware options

	Reference
PowerTouch Rechargeable	\$118 per shade pg. 83
Simplicity Wave	\$121 per shade pg. 80
Simplicity Rechargeable Motorization	\$319 per shade pg. 85
Simplicity Rechargeable Heavy Duty Motorization	\$434 per shade pg. 86
Simplicity 5 Channel Remote	\$41 per remote pg. 87
Simplicity 6 Channel Timer Remote	\$67 per remote pg. 87
Simplicity 14 Channel Remote	\$67 per remote pg. 87
Simplicity Smart Controller	\$336 per controller pg. 30
Solar Panel	\$105 per panel pg. 86
Telescoping Wand for Simplicity Wave	\$32 per wand pg. 80
Charger for Simplicity Rechargeable Motor	\$28 per charger pg. 85
Charger for Heavy Duty Rechargeable Motor	\$59 per charger pg. 86

Cordless Specifications:

Minimum width is 15½";  
Maximum Width is 96";  
Maximum Length is 96"

Tube Information for Clutch Operated Shades Only

- Section 1: Shades to the left of the dashed line requires a 1" tube/SL10" clutch
- Section 2: Shades to the right of the dashed line requires a 1½" tube/SL10 clutch
- Section 3: Shades in the blue section requires a 2" tube/SL20 clutch.
- Section 4: Shades in the orange section requires a 2½" tube/ Galaxy 200 clutch



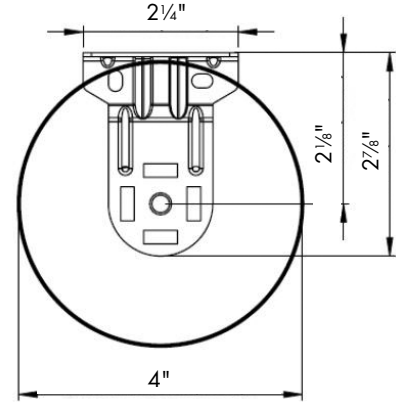
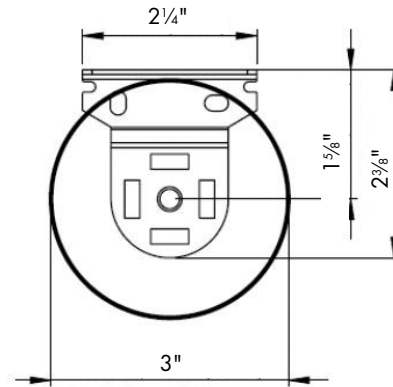

**Hardware Features**

Roll Style:	Standard or reverse (reverse roll information is found on page 72)
Bead Chain Color:	White, Black, Ivory, Satin Nickel and Bronze
Clutch Color:	White, Black, Ivory, Satin Nickel and Bronze
Bracket Cover Colors:	White, Black, Ivory, Satin Nickel and Bronze (Heavy Duty Motorization does not offer bracket covers)
Bracket Colors:	White, Black, Ivory and Bronze (Heavy Duty Motorization Brackets are white only)
Bottom Rail Style:	Fabric Wrapped or Exposed Bottom Rail
Bottom Rail Color:	Fabric Wrapped: White, Black, Ivory, Brushed Aluminum and Bronze Exposed: White, Black, Ivory, Brushed Aluminum and Bronze
<b>Motorization</b>	Skyline Standard Roller Hardware <b>can</b> be motorized with Simplicity Rechargeable Motorization and PowerTouch Rechargeable.

**Mounting Dimensions**

The standard 1" and 1 1/2" tubes are available with two brackets in 2 3/8" or 2 7/8" projection.

Minimum depth for flush inside or side mount including installation brackets: 2 1/4"

The oversized 2" tube is available with one bracket in a 2 7/8" projection.

Minimum depth for flush inside mount including installation brackets: 2 1/4"

Standard Roller Finished Dimensions	Standard Tube Cord Loop (1" & 1 1/2" diameter)	Standard Tube Motorized (1 1/2" diameter)	Oversized Tube Cord Loop (2" diameter)	Oversized Tube Cord Loop (2 1/2" diameter)	Oversized Tube Motorization (2" & 2 1/2" diameter)
<b>Inside Mount (+/- 1/8")</b>					
Bracket to Bracket:	Ordered width	Ordered width	Ordered width	Ordered width	Ordered width minus 3/16"
End to End Roller Width:	Ordered width minus 1"	Ordered width minus 1 1/8"	Ordered width minus 1 1/16"	Ordered width minus 1 1/4"	Ordered width minus 2 3/16"
Fabric Width:	Ordered width minus 1 1/16"	Ordered width minus 1 3/16"	Ordered width minus 1 1/8"	Ordered width minus 1 5/16"	Ordered width minus 2 1/4"
Bottom Rail Width:	Ordered width minus 1 1/16"	Ordered width minus 1 3/16"	Ordered width minus 1 1/8"	Ordered width minus 1 5/16"	Ordered width minus 2 1/4"
<b>Outside Mount and Inside Mount with Bracket Covers (+/- 1/8")</b>					
End Cap Cover to End Cap Cover:	Ordered width	Ordered width	Ordered width	Ordered width	N/A
Bracket to Bracket:	Ordered width minus 1/8"	Ordered width minus 1/4"	Ordered width minus 1/8"	Ordered width minus 1 1/8"	Ordered width minus 3/16"
End to End Roller Width:	Ordered width minus 1 1/8"	Ordered width minus 1 1/4"	Ordered width minus 1 3/16"	Ordered width minus 1 3/8"	Ordered width minus 1 13/16"
Fabric Width:	Ordered width minus 1 3/16"	Ordered width minus 1 5/16"	Ordered width minus 1 1/4"	Ordered width minus 1 7/16"	Ordered width minus 1 7/8"
Bottom Rail Width:	Ordered width minus 1 3/16"	Ordered width minus 1 5/16"	Ordered width minus 1 1/4"	Ordered width minus 1 7/16"	Ordered width minus 1 7/8"

# Color Lux® Roller Shades

## SKYLINE CORD LOOP HARDWARE OPTIONS



Skyline Hardware in White



Skyline Hardware in Ivory



Skyline Hardware in Black



Skyline Hardware in Bronze



Skyline Hardware in Satin Nickel

### Tensioners for Cord Loop Shades

Cord Loop Roller Shades feature a new tensioner design for easy mounting and smooth operation. Available in five finishes that matches the clutch control on Skyline Cord Loop roller shades, now every part of a Skyline Roller shade will coordinate from top to bottom.



White Tensioner



Black Tensioner



Ivory Tensioner



Bronze Tensioner



Satin Nickel Tensioner

### Color Lux Roller Shade Cord Loop Information

Color Lux Roller Shades are available with a choice of colored bead chain colors.

- Select white, black, bronze or steel bead chain with the Standard Roller, Fascia, and Designer Cassette head rail options.
- The bead chain will measure the length indicated below unless otherwise specified.

SHADE HEIGHT	LOOP DROP
12" to 15 <sup>7</sup> / <sub>8</sub> "	<sup>2</sup> / <sub>3</sub> of shade height
16" to 29 <sup>7</sup> / <sub>8</sub> "	<sup>3</sup> / <sub>4</sub> of shade height
30" - 35 <sup>7</sup> / <sub>8</sub> "	24" Loop
36" - 41 <sup>7</sup> / <sub>8</sub> "	30" Loop
42" - 47 <sup>7</sup> / <sub>8</sub> "	36" Loop
48" - 53 <sup>7</sup> / <sub>8</sub> "	42" Loop
54" - 59 <sup>7</sup> / <sub>8</sub> "	48" Loop
60" - 65 <sup>7</sup> / <sub>8</sub> "	54" Loop
66" - 71 <sup>7</sup> / <sub>8</sub> "	60" Loop
72" - 77 <sup>7</sup> / <sub>8</sub> "	66" Loop
78" - 89 <sup>7</sup> / <sub>8</sub> "	72" Loop
90" - 101 <sup>7</sup> / <sub>8</sub> "	84" Loop
102" - 113 <sup>7</sup> / <sub>8</sub> "	96" Loop
114" - above	<sup>3</sup> / <sub>4</sub> of shade height

- Bead chain can be ordered in custom lengths. Maximum bead chain length is 15 feet.

**Color Lux® Roller Shades**  
**CORDLESS ROLLER WITH DECO-BAR HARDWARE SYSTEM**



**Shades Measuring 15½" to 72":**

- A = 1½"
- B = 1⅝"
- C = 2¼"
- D = 1¼" Roller

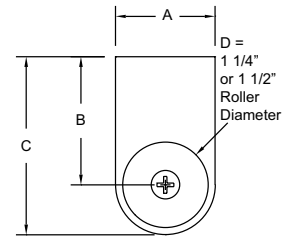

**Shades Measuring 72" to Maximum Width:**

- A = 1¾"
- B = 1¾"
- C = 2¾"
- D = 1½" Roller

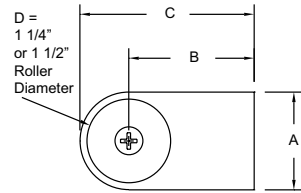

**Head Rail Consistency**

Fabric will add an average of ⅛" to the diameter of the tube for every 10" of fabric rolled onto the tube. Contact Technical Services if additional services is needed.

**Hardware Features**

Roll Style:	Standard or reverse (reverse roll information is found on page 72)
Hardware Color:	White, Ivory, Black, Satin Nickel and Bronze (brackets are white or black)
Bracket Covers:	White, Ivory, Black, Satin Nickel and Bronze
Bottom Rail Style:	Fabric Wrapped or Exposed Bottom Rail
Bottom Rail Color:	Fabric Wrapped: White, vanilla, bronze, black or brushed aluminum Exposed: White, vanilla, bronze, black or brushed aluminum
<b>Motorization</b>	Cordless Roller with Deco-Bar <b>cannot</b> be motorized.
<b>Head Rail Surcharge</b>	See price grids for Cordless surcharge information.

**Mounting Dimensions**

Minimum depth for flush inside mount including installation brackets: 1¾"
Minimum inside mounting height: 1¼"
Minimum outside mounting height: 1"

**Cordless Roller with Deco-Bar Finished Dimensions (+/- ⅛")**

**Inside Mount**

Head Rail Measurement:	Ordered width minus ⅜" (measurement includes end brackets)
Fabric Width:	Ordered width minus 13/16"

**Inside Mount with Bracket Covers**

Head Rail Measurement:	Ordered width minus 7/16"
Fabric Width:	Ordered width minus 1 1/16"

**Outside Mount**

Head Rail Measurement:	Ordered width plus ⅜" (measurement includes end brackets)
Fabric Width:	Ordered width minus 7/16"

**Side Mount**

Head Rail Measurement:	Ordered width minus 1 1/16" (measurement includes end brackets)
Fabric Width:	Ordered width minus 1 5/16"

**Exact End to End Mount**

Head Rail Measurement:	Ordered width (measurement includes end brackets)
Fabric Width:	Ordered width minus 5/8"

COLORLUX® ROLLER SHADES

**Cordless Roller Shades with Designer Cassette**

Create a sleek look with the Designer Cassette Head Rail. Available in White, Ivory, Black, Satin Nickel and Bronze. See individual fabric specifications for minimum and maximum shade sizes. Cordless Roller Shades with Designer Cassette are available with the Smooth Face, Fabric Insert or Fabric Wrapped options.



Designer Cassette with Smooth Face in White



Designer Cassette with Smooth Face in Ivory



Designer Cassette with Smooth Face in Black



Designer Cassette with Smooth Face in Oil Rubbed Bronze



Designer Cassette with Smooth Face in Satin Nickel

**Cordless Roller DecoBar**

This cord-free system operates like a spring roller shade with a gentle tug on the bottom rail to raise and lower the shade. See page 69 for mounting information and finished dimension information. Reverse roll is available for the Deco-Bar Cordless option



White Cordless Roller Deco-Bar



Black Cordless Roller Deco-Bar



Ivory Cordless Roller Deco-Bar



Bronze Cordless Roller Deco-Bar



Satin Nickel Cordless Roller Deco-Bar

**Cordless Roller Deco-Bar Bracket Covers**

The Cordless Roller Decobar now offers deco bar covers in White, Ivory, Black, Satin Nickel and Bronze that coordinates with the deco-bar color selected. Available for Inside Mount or Outside Mount applications. Brackets are White and Black only.



Bracket cover provides a clean finished appearance

# Color Lux® Roller Shades

## CORDLESS OPERATION

### Cordless Tassels and Pulls

Add a decorative tassel or pull to help facilitate easy operation and keep the fabric on the bottom rail clean on all Cordless Shades. Tassels and pulls are placed in the middle of the bottom rail. They feature an approximately 3-inch long cord which coordinates with the tassel color.

Tassels and pulls are attached to the back of the bottom rail with a clear clip. This allows for in the field modifications if needed.

### Clear Handle for Cordless Roller Shades

A clear handle comes included with all cordless roller shade orders with an option to attach the handle during installation. This easy to attach and easy to remove clear handle is a great way to keep the rail or the fabric (for fabric wrapped option) clean and new after regular shade use. The width of the handle is 2 1/8" wide.



Optional Clear Handle

**ALL Color Lux Roller Shade hardware is available with any Tassel or Pull.**

### Wood Ball Pulls

Add a decorative Wood Ball Pull to help facilitate easy operation and keep the fabric on the bottom rail clean on all Color Lux Roller Shades. Select from 4 colors: Waxed, Natural, Whitewash and Cocoa.

**Add: \$18 Per Shade**



Cocoa      Whitewash      Waxed      Natural

### Beehive Pulls

Add a durable and fashionable Beehive Pull to your shades for easy lifting and lowering. These are a great combination with solar shades and are available in White and Onyx.

The Beehive pull is 2 5/8" long.

**Add: \$42 Per Shade**



Onyx      White

### Wood Tassels

Select from 5 colors: Milky White, Ebony, Walnut, Light Pine or Mahogany.

A wood tassel is 1 5/16" long.

**Add \$18 Per Shade**



COLORLUX® ROLLER SHADES

# Color Lux® Roller Shades

## GENERAL INFORMATION

### Reverse Roll on Color Lux Roller Shades

A reverse roll option is available at no extra charge with all Color Lux Roller Shade fabrics only on the Standard Roller Hardware and Cordless Roller with Deco-Bar Hardware. The reverse roll allows the fabric to roll off the front of the roller instead of the back (the traditional style). The reverse roll conceals the roller for a contemporary, tailored appearance.



White Cordless Roller with Deco-Bar in Standard Roll



Black Cordless Roller with Deco-Bar in Standard Roll



White Cordless Roller with Deco-Bar in Reverse Roll



Black Cordless Roller with Deco-Bar in Reverse Roll



Standard Roller in Standard Roll



Standard Roller in Reverse Roll

### Bottom Rail Options

Color Lux Roller Shades can be built with your choice of 2 bottom rail options:

- Fabric Wrapped Bottom Rail (standard)
- Exposed Bottom Rail

Choose your bottom rail color when ordering.

#### Fabric Wrapped Bottom Rail

The shade fabric is wrapped around an elliptical grooved rail. Two clear plastic end caps secure the fabric in place. Select from bronze, white, vanilla, black or brushed aluminum.

Choose your bottom rail color when ordering.



Fabric Wrapped Bottom Rail

#### Exposed Bottom Rail

Select from bronze, white, vanilla, black or brushed aluminum bottom rail to add a decorative accent to the bottom of your shade. Two clear plastic end caps secure the fabric in place.

Choose your bottom rail color when ordering.



Bronze Exposed Bottom Rail



**DESIGNER CASSETTE WITH INSERT STRIP HARDWARE SYSTEM**



Insert Strip



Fabric Wrap



Smooth Face

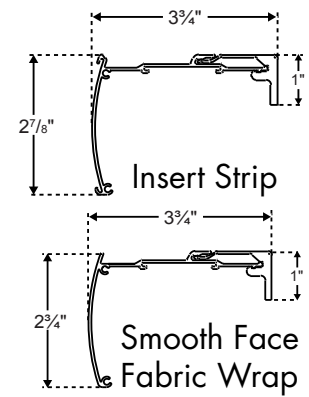

**Hardware Features**

Roll Style:	Standard only
Head Rail Color:	White, Ivory, Black, Satin Nickel and Bronze with matching fabric insert strip Skyline Clutch is available in White, Ivory, Black, Satin Nickel and Bronze
Bottom Rail Style:	Fabric Wrapped or Exposed Bottom Rail
Bottom Rail Color:	Fabric Wrapped: White, vanilla, bronze, black or brushed aluminum Exposed: White, vanilla, bronze, black or brushed aluminum
Bead Chain Color:	White, ivory, black, bronze or steel bead chain
Operation Options:	Cord Loop: Select bead chain color, bottom rail style and color Cordless: Select bottom rail style and color
<b>Motorization</b>	Designer Cassette <b>can</b> be motorized with Simplicity Rechargeable Motorization and Powertouch Rechargeable. See pages 83 - 87 for more details.

**Mounting Dimensions**

Minimum depth for flush inside mount including installation brackets: 3 3/4"

Minimum depth required for shallow mounting: 1"

Minimum depth for side mount: 1 1/8" • Maximum shade width for side mount: 48"

Minimum height required for outside mounting: 1"

**Designer Cassette Finished Head Rail Measurements for Cord Loop, Cordless and Motorized Shades (+/- 1/8")**

**Inside Mount**

Head Rail Measurement: Ordered width minus 3/16" (measurement includes end caps)

**Outside Mount**

Head Rail Measurement: Ordered width plus 3/16" (measurement includes end caps)

**Side Mount**

Head Rail Measurement: Ordered width minus 1 1/16" (measurement includes end caps)

**Exact End to End Mount**

Head Rail Measurement: Ordered width (measurement includes end caps)

**Designer Cassette Finished Fabric Measurements (+/- 1/8")**

Mount	Cord Loop & Motorized	Cordless	Skyline Cord Loop
Inside Mount:	Ordered width minus 1 1/16"	Ordered width minus 1"	Ordered width minus 1 1/4"
Outside Mount:	Ordered width minus 1 1/16"	Ordered width minus 5/8"	Ordered width minus 7/8"
Side Mount:	Ordered width minus 1 9/16"	Ordered width minus 1 1/2"	Ordered width minus 1 3/4"
Exact End to End Mount:	Ordered width minus 7/8"	Ordered width minus 1 3/16"	Ordered width minus 1 1/16"



# Color Lux® Roller Shades

## TWO-ON-ONE HEAD RAIL SYSTEM

Two on One Head Rail roller shades are two roller shades sharing the same head rail; each roller operates independently.

### Operating Options

- Two on One Head Rail can be combined with cord loop, PowerTouch Motorization, Simplicity Motorization and Simplicity Rechargeable Motorization hardware options.
- Controls will always be placed to the far left and far right. (Controls are NOT available between two shades)

### Fabric Options

- Two on One Head Rail roller shades are available in all Color Lux Roller Shade fabrics.
- See price grids for standard size limitations.



## Two-on-One No Head Rail Shades

The Two-on-One No Head Rail mounting option uses an intermediate bracket that reduces the light gap when two shades are placed side-by-side.

Cord Loop shades will always have the clutch on the outside of both shades to ensure proper tensioner mounting.

Standard Brackets are available in White, Black, Ivory and Bronze. Intermediate Brackets are available in White, Black and Ivory.

Bracket covers for the two outer shades are the same colors available for a Skyline Standard Roller Shade: White, Black, Ivory, Bronze and Satin Nickel.

Two-on-One No Head Rail Shades are available with Cord Loop, Simplicity Motorization, Simplicity Rechargeable Motorization and PowerTouch Rechargeable shades.

PowerTouch Rechargeable wands will always hang to the outside of each Two-on-One No Head Rail shade.

### Head Rail Options

- Available with Designer Cassette or Standard Roller Shades.
- Two on One roller shades are ONLY available on 1½" tube.
- Available with Designer Cassette with Insert Strip and Smooth Face options.
- Fabric wrapping is NOT available on two on one Designer Cassette.
- Minimum single section is 12".
- Maximum width for a single section is 106".
- Total maximum width in Designer Cassette head rail is 140". Maximum shade sizes will vary by fabric
- Center gap between roller shades is 3/8".

### TWO ON ONE CASSETTE PRICING EXAMPLE:

36" x 60" Classic Duck	
Blackout Fabric	\$346 x 2 = \$692
Designer Cassette Insert Strip	\$90 x 2 = \$180
PowerTouch Motorization:	\$118 x 2 = \$236

### TOTAL LIST PRICE BEFORE DEALER DISCOUNT = \$1,108

- Specify shade total width and the two individual section widths. **Please Note:** The two individual sections must add up to the total width.

### TWO ON ONE NO CASSETTE PRICING EXAMPLE:

For Satin Nickel Two-on-One No Head Rail Shades with PowerTouch Rechargeable:

36 x 60 Linen Light Filtering Fabric:	\$312 x 2 = \$624
Add Satin Nickel Skyline:	\$28 x 2 = \$56
Add PowerTouch Rechargeable:	\$118 x 2 = \$236

### TOTAL LIST PRICE BEFORE DEALER DISCOUNT = \$916

Color Lux® Roller Shades

DUAL ROLLER WITH CORDLOOP & SIMPLICITY RECHARGEABLE MOTORIZATION

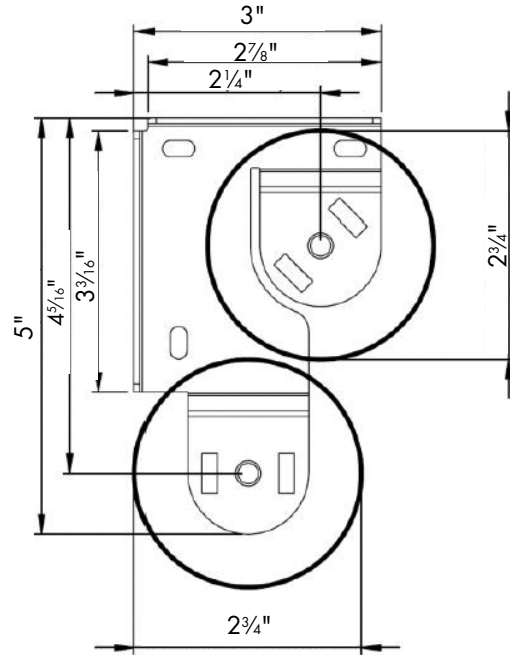

COLORLUX® ROLLER SHADES

**Hardware Features**

Roll Style:	Standard and reverse roll is required (reverse roll information is found on page 72)
Bead Chain Color:	White, Ivory, Black, Satin Nickel and Bronze
Clutch Color:	White, Ivory, Black, Satin Nickel and Bronze (Skyline Hardware Only)
Bracket Cover Colors:	Bracket Covers are Not Available
Bracket Colors:	White and Black
Bottom Rail Style:	Fabric Wrapped or Exposed Bottom Rail
Bottom Rail Color:	Fabric Wrapped: White, Black, Ivory, Brushed Aluminum and Bronze Exposed: White, Black, Ivory, Brushed Aluminum and Bronze
Tensioner Colors:	White, Ivory, Black, Satin Nickel and Bronze

**Motorization**

Dual Roller Shade Hardware **can** be motorized with Simplicity Rechargeable Motorization. PowerTouch Rechargeable is not available. See page 85 - 87 for motorization details.

**Mounting Dimensions**

Minimum depth for flush inside mount including installation brackets: 3"

Minimum depth required for side mounting: 1"

Standard Roller Finished Dimensions (+/- 1/8")	Standard Tube (1" and 1 1/2" diameter)	Oversized Tube (2" diameter)
<b>Inside Mount and Outside Mount</b>		
Bracket to Bracket Measurement:	Ordered width	Ordered width
End to End Roller Width:	Ordered width minus 1"	Ordered width minus 1 1/16"
Fabric Width:	Ordered width minus 1 1/16"	Ordered width minus 1 1/8"
Bottom Rail Width:	Ordered width minus 1 1/16"	Ordered width minus 1 1/8"

# Color Lux® Roller Shades

## DUAL ROLLER HARDWARE SYSTEM

Dual Roller Shades are available with Skyline Cord Loop and Simplicity Rechargeable Motorization. They are the perfect way to combine both light filtering and blackout fabrics into a single shade for the ultimate light control. Any fabric or screen in the Envision Designer Collection can be mixed and matched to create a versatile window for any time of day.

The front roll of fabric is always a reverse roll. The back roll of fabric is always a standard roll. Clutches are always on opposite sides of the shade to ensure a location for tensioner mounting.

Dual Roller Shades are not available with cordless operation or PowerTouch Rechargeable motorization. Bracket covers are available in white or black for outside mount shades only. Brackets are available in black and white.

Candeling will occur between the upper and lower fabric rolls if a Blackout fabric is selected as the back roll. This allows light to come through. Blackout fabric can be selected for the front roll to prevent this.

Simplicity Rechargeable Motorization is available with Dual Roller Shades to ensure easy installation without the need to mount two battery wands.

See price grids for Dual Roller Shade Specifications. Shade minimums and maximums are identical to single shade systems. Not available with 2" tube.

COLORLUX® ROLLER SHADES



Candeling when Blackout Fabric is selected as the back roll.



Tensioners are mounted on opposite side of a Dual Roller Shade



Distance between rollers when front shade is raised all the way

### DUAL ROLLER SHADE PRICING EXAMPLE:

For Satin Nickel Dual Roller Shades:	
Front Shade 36 x 60 Linen Light Filtering:	\$312
Back Shade 36 x 60 Linen Blackout:	\$346
Satin Nickel Skyline Clutch Surcharge: $\$28 \times 2 =$	\$56
Add Dual Roller Shade Surcharge:	\$28
<b>TOTAL LIST PRICE BEFORE DEALER DISCOUNT =</b>	<b>\$742</b>

**DESIGNER CASSETTE WITH RETRACTABLE CORD HARDWARE SYSTEM**

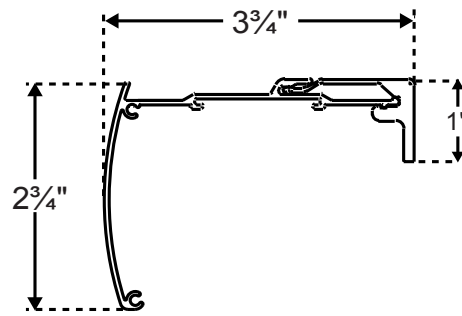

COLORLUX® ROLLER SHADES

**Hardware Features**

Roll Style:	Standard only
Head Rail Color:	White, Ivory, Black, Satin Nickel and Bronze Retractable Cord Clutch is available in White and Black only
Bottom Rail Style:	Fabric Wrapped or Exposed Bottom Rail
Bottom Rail Color:	Fabric Wrapped: White, vanilla, bronze, black or brushed aluminum Exposed: White, vanilla, bronze, black or brushed aluminum
Cord Color:	White or Black Cord and Tassel to coordinate with clutch

**Cassette Surcharge** See price grids for surcharge information.

**Mounting Dimensions**

Minimum depth for flush inside mount including installation brackets: 3 3/4"
Minimum depth required for shallow mounting: 1"
Minimum depth for side mount: 1 1/8" • Maximum shade width for side mount: 48"
Minimum height required for outside mounting: 1"

**Designer Cassette Finished Head Rail Measurements for Retractable Cord (+/- 1/8")**

Inside Mount	
Head Rail Measurement:	Ordered width minus 3/16" (measurement includes end caps)
Outside Mount	
Head Rail Measurement:	Ordered width plus 3/16" (measurement includes end caps)
Side Mount	
Head Rail Measurement:	Ordered width minus 1 1/16" (measurement includes end caps)
Exact End to End Mount	
Head Rail Measurement:	Ordered width (measurement includes end caps)

**Designer Cassette Finished Fabric Measurements (+/- 1/8")**

Mount	Retractable Cord
Inside Mount:	Ordered width minus 1 7/16"
Outside Mount:	Ordered width minus 1 1/16"
Side Mount:	Ordered width minus 1 5/16"
Exact End to End Mount:	Ordered width minus 1 1/4"

# Color Lux® Roller Shades

## DESIGNER CASSETTE WITH RETRACTABLE CORD HARDWARE SYSTEM

The Retractable Cord system for Color Lux Roller Shades is a perfect option for hard to reach shades when a continuous loop is not desired. The retractable cord system features smooth and easy to use operation. The Designer Cassette option is required for all Retractable Cord shades.

### Colors

Clutch: is available in White or Black. Can be coordinated with any Designer Cassette option.

Cords and Tassels: White or Black

### Operation

The clutch can be ordered to the right or left of of the shade so the pull cord is easy to reach.

To raise, simply pull the cord straight down until it reaches full extension and then allow the cord to retract completely into the head rail. Each stroke partially raises the shade. The shade can be stopped at any point while raising.

To lower, simply pull the cord out towards you until it reaches full extension and then allow the cord to retract completely into the head rail. Each stroke partially lowers the shade. The shade can be stopped at any point while lowering.

### Light Gap

Please note that there is a 3/4" light gap on the operation side of all roller shades.

Minimum ordered width for Retractable Cord shades is 12". See fabric specification pages for maximum sizes.

### Cord Length

All retractable cord shades have a default cord length that is 40% of the total length. Custom options are available when ordering.



3/4" light gap on operation side. Clutches are available in white and black with tassels and cords in white or black

Color Lux Retractable Cord Pricing Example:	
36 x 60 Linen Light Filtering Fabric:	\$312
Add Retractable Cord Surcharge:	\$42
<b>TOTAL LIST PRICE BEFORE DEALER DISCOUNT = \$354</b>	

COLORLUX® ROLLER SHADES

**DESIGNER CASSETTE WITH SIMPLICITY WAVE HARDWARE SYSTEM**

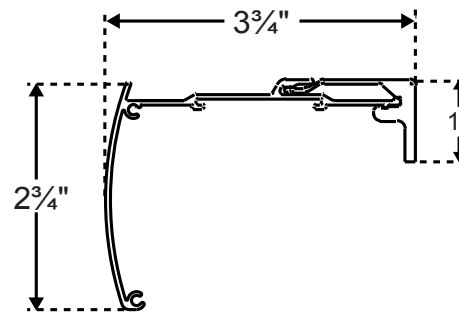

**Hardware Features**

Roll Style:	Standard only
Head Rail Color:	White, Ivory, Black, Satin Nickel and Bronze Simplicity Wave is available with smooth face, fabric wrapped and insert strip Designer Cassette
Bottom Rail Style:	Fabric Wrapped or Exposed Bottom Rail
Bottom Rail Color:	Fabric Wrapped: White, vanilla, bronze, black or brushed aluminum Exposed: White, vanilla, bronze, black or brushed aluminum
Bead Chain Color:	White, black, bronze or steel bead chain
<b>Motorization</b>	See page 80 for pricing and more information on Simplicity Wave Motorization.
<b>Cassette Surcharge</b>	See price grids for surcharge information.

**Mounting Dimensions**

Minimum depth for flush inside mount including installation brackets:	3 3/4"
Minimum depth required for shallow mounting:	1"
Minimum depth for side mount:	1 1/8" • Maximum shade width for side mount: 48"
Minimum height required for outside mounting:	1"

**Designer Cassette Finished Head Rail Measurements for Cord Loop, Cordless and Motorized Shades (+/- 1/8")**

<b>Inside Mount</b>	
Head Rail Measurement:	Ordered width minus 3/16" (measurement includes end caps)
<b>Outside Mount</b>	
Head Rail Measurement:	Ordered width plus 3/16" (measurement includes end caps)
<b>Side Mount</b>	
Head Rail Measurement:	Ordered width minus 1 1/16" (measurement includes end caps)
<b>Exact End to End Mount</b>	
Head Rail Measurement:	Ordered width (measurement includes end caps)

**Designer Cassette Finished Fabric Measurements (+/- 1/8")**

Mount	Simplicity Wave Motorization
Inside Mount:	Ordered width minus 1 1/16"
Outside Mount:	Ordered width minus 1 1/16"
Side Mount:	Ordered width minus 1 9/16"
Exact End to End Mount:	Ordered width minus 7/8"



# Color Lux® Roller Shades

## DESIGNER CASSETTE WITH SIMPLICITY RECHARGEABLE ROLLER WAVE \_\_\_\_\_

### Simplicity Rechargeable Roller Wave

The Simplicity Wave Motor features a roller motor with integrated batteries. Simplicity Wave requires a Designer Cassette option and uses a telescoping wand to raise or lower the shade.

The Simplicity Rechargeable Roller Wave option is available in all sizes in Section 1 of each fabric price grid.

#### Please Note:

- Not all motors run at the same rate of speed.
- Simplicity Rechargeable Roller Wave shades are programmed at the factory with the “up” and “down” limits.
- Order at least one charger.

### Telescoping Wand

- Extends to 33” for hard to reach shades.
- Wand retracts to 9” for easy storage.
- Wand is silver with white handle and white magnetic tip.
- Wall mount plate included for convenience.
- Wand is universal and will operate all Simplicity Wave shades.



### Battery Charger

8.4 Volt charger requires a standard power outlet to recharge the battery integrated within the motor. Must specify charger when ordering a PowerTouch Rechargeable shade. The charger plugs into the charger port. The charger is black and comes with a 156” (13’) wire.



### Mounting Requirements for Simplicity Rechargeable Wave with Designer Cassette

No special installation hardware or wiring requirements are needed to install Simplicity Wave Roller Shades with Designer Cassette Head Rail. A battery wand is not required.



### Simplicity Wave for Roller Shades

Standard Color Lux Discounts apply to motorized lift systems pricing.

#### Motor

- Radio Frequency Motor \$121.00  
Includes integrated rechargeable battery

#### Simplicity Wave Wand

- Telescoping Wand \$32.00

#### Simplicity Rechargeable Motor Battery Charger

- Charger for rechargeable motors (required): \$28.00

4" SKYLINE FASCIA WITH CORD LOOP AND SIMPLICITY MOTORIZATION

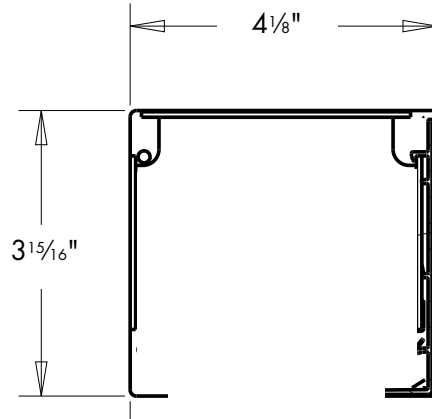

**Hardware Features**

Fascia Colors:	White, Ivory, Black, Satin Nickel and Bronze
Roll Style:	Standard only
Bead Cord Style and Color:	White, Ivory, Black, Satin Nickel and Bronze
Skyline Clutch Colors:	White, Ivory, Black, Satin Nickel and Bronze
Bottom Rail Style:	Fabric Wrapped or Exposed Bottom Rail
Bottom Rail Color:	Fabric Wrapped: White, Black, Vanilla, Brushed Aluminum and Bronze Exposed: White, Black, Vanilla, Brushed Aluminum and Bronze
Tensioner Color:	White, Ivory, Black, Satin Nickel and Bronze
<b>Motorization</b>	4" Skyline Fascia <b>can</b> be motorized with Simplicity Rechargeable Motorization or PowerTouch™ Rechargeable. See grids for pricing and pages 83 - 87 for motorization details.

**Mounting Dimensions**

Minimum depth for flush inside mount including installation brackets: 4 1/8"
Minimum surface height required for outside mount: 4"
4" Inch Skyline Fascia can be installed as an inside mount with bracket covers.

Standard Roller Finished Dimensions (+/- 1/8")	Standard Tube (1" and 1 1/2" diameter)	Oversized Tube (2" diameter)
<b>Inside Mount</b>		
Bracket to Bracket Measurement:	Ordered width	Ordered width
End to End Roller Width:	Ordered width minus 1"	Ordered width minus 1 1/16"
Fabric Width:	Ordered width minus 1 1/16"	Ordered width minus 1 1/8"
Bottom Rail Width:	Ordered width minus 1 1/16"	Ordered width minus 1 1/8"
<b>Outside Mount and Exact Mount</b>		
End Cap Cover to End Cap Cover:	Ordered width	Ordered width
Bracket to Bracket Measurement:	Ordered width minus 1/8"	Ordered width minus 1/8"
End to End Roller Width:	Ordered width minus 1 1/8"	Ordered width minus 1 3/16"
Fabric Width:	Ordered width minus 1 3/16"	Ordered width minus 1 1/4"
Bottom Rail Width:	Ordered width minus 1 3/16"	Ordered width minus 1 1/4"

COLORLUX® ROLLER SHADES

# Color Lux® Roller Shades

## 4" SKYLINE FASCIA WITH CORD LOOP AND SIMPLICITY MOTORIZATION



Motorized 4" Fascia in White

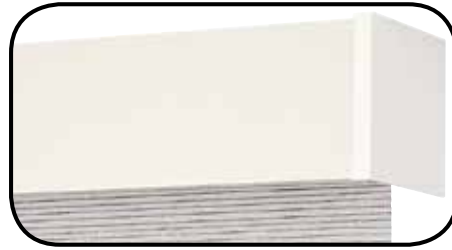

Motorized 4" Fascia Ivory



Motorized 4" Fascia in Black

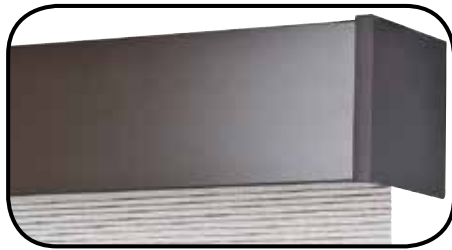

Motorized 4" Fascia in Bronze



Motorized 4" Fascia in Satin Nickel

### General Information

The 4" Skyline Fascia is a roller only shade with a 4" Skyline Fascia upgrade. The fascia clips over the standard roller shade during installation.

**Inside Mount** - Bracket covers are not available for inside mount shades due to the snap on installation method of the covers.

**Outside Mount** - Bracket covers are standard with all outside mount shades.

### Operation Options

Skyline Clutch

PowerTouch Rechargeable Motorization

Simplicity Rechargeable Motorization

# Color Lux® Roller Shades

## POWERTOUCH RECHARGEABLE FOR NO HEAD RAIL & DESIGNER CASSETTE

Color Lux Roller Shades can be fabricated with the PowerTouch™ Rechargeable option.

The PowerTouch™ Rechargeable provides an easy, cord free motorized operation for the budget savvy homeowner. PowerTouch™ Rechargeable uses Simplicity motors and components.



- PowerTouch™ Rechargeable is available for Roller Only and Designer Cassette
- The Roller Only option uses Skyline Hardware brackets and bracket covers available in White, Ivory, Black, Satin Nickel and Bronze. Wand and Pendant are always White or Black.

### Color Lux Roller Shade PowerTouch™ Rechargeable Upgrade Surcharges

All standard discounts apply to PowerTouch™ Shades.

- PowerTouch™ Rechargeable Pendant and Wand: \$118.00
- Charger for PowerTouch™ Rechargeable (required): \$28.00

### PowerTouch™ Rechargeable Roller Shade Specifications

See specific fabric price grids for minimum and maximum shade widths and lengths. Shade sizes in grey shaded sections are NOT available with the PowerTouch™ Rechargeable option.

### PowerTouch™ Rechargeable Shades Operation

Press the up or down button on the pendant to raise or lower the shading to your desired position.

Programming the upper and lower limits is completed at the factory. These can be easily adjusted in the field if desired.

Programming the favorites position is completed after shade installation.

Please refer to the installation instructions at [comfortex.com/comfortex-dealers](http://comfortex.com/comfortex-dealers).

### PowerTouch™ Rechargeable Appearance

- The PowerTouch™ Rechargeable wand and pendant is attached to the head rail and requires no additional mounting.
- The No Head Rail PowerTouch™ Rechargeable wand must be attached to the motor before mounting.
- The wand and pendant hangs down the front of the shades
- The top and bottom buttons lift and lower the shade to the upper and lower limits. The center button is the favorites and stop button. from the head rail. The wand does not touch the fabric.
- Pendant is 2½" long.

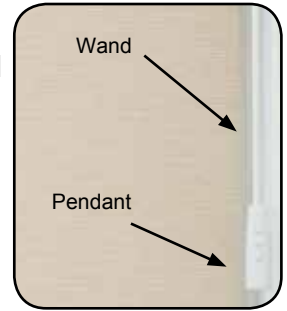

### PowerTouch™ Rechargeable Color Options with Designer Cassette and No Head Rail Roller



White



Black

- Shades with Black or Oil Rubbed Bronze head rail will be built with black wand and pendants standard.
- Shades with White hardware will be built with white wand and pendants standard.
- Shades with Fabric Wrapped Head Rail will be built according to the head rail color selected.
- Shades booked as a no head rail roller will have a prompt to select wand color.

### Wand and Pendant Location with Designer Cassette and No Head Rail Roller

The standard location for the wand and pendant is on the right. Please specify when ordering.

# Color Lux® Roller Shades

## POWERTOUCH RECHARGEABLE FOR NO HEAD RAIL & DESIGNER CASSETTE

### PowerTouch™ Rechargeable Wand Length with Designer Cassette and No Head Rail Roller

Shade Length	Standard Wand Length
Shades up to 30"	1' (12")
30" to 52"	2' (24")
52" to 78"	3' (36")
78" to 100"	4' (48")
100" to 120"	5' (60")

- Custom length wands are not available with PowerTouch™ Rechargeable. Standard wand lengths can be changed at no cost.

### Mounting Requirements for PowerTouch™ Rechargeable Shades with Designer Cassette

- No special installation hardware or wiring requirements are needed to install PowerTouch™ Rechargeable Roller Shades with Designer Cassette Head Rail.
- A battery wand is not required with PowerTouch™ Rechargeable shades.

### Mounting Requirements for PowerTouch™ Rechargeable Shades with No Head Rail Roller

- On No Head Rail roller shades, the wand must be attached to the motor with two screws (included) before mounting the shade.
- A battery wand is not required with PowerTouch™ Rechargeable shades.

### PowerTouch™ Rechargeable Shades Do Not Have a Separate Battery Wand

There is no battery wand with the PowerTouch™ Rechargeable shades. The battery pack is integrated inside the roller tube to make mounting easier and more convenient.

The battery is recharged via the recharging port on the PowerTouch Rechargeable™ Wand.



Recharging Port

### Minimum Width Requirements for PowerTouch™ Rechargeable Shades with and without Designer Cassette

Inside Mount = 18<sup>3</sup>/<sub>8</sub>"  
 Exact Mount = 18<sup>3</sup>/<sub>16</sub>"  
 Outside Mount = 18"

### Battery Charger

8.4 Volt charger requires a standard power outlet to recharge the battery integrated within the motor. Must specify charger when ordering a PowerTouch Rechargeable shade. The charger plugs into the charger port. The charger is black and comes with a 156" (13') wire.



### PowerTouch™ Rechargeable Roller Shades Warranty

Please see page 136 for complete Comfortex warranty information.

# Color Lux® Roller Shades

## SIMPLICITY RECHARGEABLE MOTORIZATION

The Simplicity Rechargeable Motorization program features an integrated rechargeable lithium ion battery in the motor casing and is fully concealed by the roller tube.

### Simplicity Rechargeable Motorization Upgrades and Surcharges

<b>Motor</b>	
• Radio Frequency Motor: Includes integrated rechargeable battery	\$319.00
<b>Hand Held Remote</b>	
• 5 Channel Remote:	\$41.00
• 6 Channel Timer Remote:	\$67.00
• 14 Channel Remote	\$67.00
<b>Simplicity Rechargeable Motor Battery Charger</b>	
• Charger for rechargeable motors (required):	\$28.00
<b>Simplicity Smart Controller</b>	
• Smart Controller Unit	\$336.00
<b>Simplicity Solar Panel</b>	
• Solar Panel for Rechargeable Remote	\$105.00
<b>All standard discounts apply.</b>	

### Simplicity Rechargeable Motorization

#### All Roller Shade Fabrics

Minimum Width: 18"  
Maximum Width: See roller price grids for motorized shades specifications.

#### Simplicity Rechargeable Motors Appearance with No Head Rail Roller and Designer Cassette Head Rail

The Simplicity Rechargeable motor and batteries are concealed within the roller tube.

#### Mounting Requirements Standard Skyline Roller Hardware

No special installation hardware or wiring requirements are needed. See page 67 for mounting information.

**Dual Roller Shades**  
No special installation hardware or wiring requirements are needed. See page 75 for mounting information.

**Designer Cassette Hardware**  
No special installation hardware or wiring requirements are needed. See page 73 for mounting information.

**4" Skyline Fascia Hardware**  
No special installation hardware or wiring requirements are needed. See page 81 for mounting information.

### Simplicity Rechargeable Motor Batteries

The battery for the integrated rechargeable simplicity motor system is integrated within the motor casing and is fully concealed by the roller tube.

Rechargeable battery comes fully charged from the factory.

### Battery Wand Mounting is Not Required

No external battery wand is required to operate a Color Lux Roller Shade with Simplicity Rechargeable Motorization.

### Simplicity Rechargeable Motor Battery Life

Rechargeable battery is built into the motor.

The average battery charge will last 6-12 months based on an average sized shade raised and lowered once per day. The life of the battery charge will vary based on the type of window covering selected, the size and weight of the window covering and the number of times the shade is operated on a daily basis.

The battery can be recharged up to 500 times. It takes approximately 5 hours to recharge the motor when fully depleted.

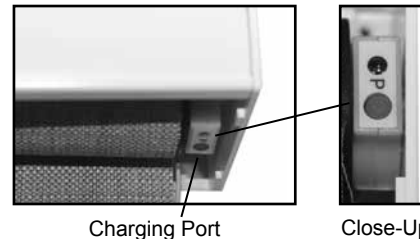

### Battery Charger for Simplicity Rechargeable Motors

An 8.4 Volt charger requires a standard power outlet to recharge the battery. The charger must be specified when ordering a Rechargeable Simplicity Motorized shade. The charger plugs into the charging port of the motor.

The charger is black and comes with a 156" (13') wire. The dimensions are 1" wide x 2½" length x 1¾" deep.



COLORLUX® ROLLER SHADES



# Color Lux® Roller Shades

## SIMPLICITY RECHARGEABLE MOTORIZATION

### Heavy Duty Simplicity Rechargeable Motorization for 2" and 2½" tubes

Heavy Duty Motors are now available for all roller shades that require a 2" or 2½" tube. See shaded sections in each fabric grid for sizes. Motors are only available with the no head rail option. Brackets are only white and no bracket covers are available. Even if not required, Heavy Duty Motorization can be ordered for smaller shades to maintain consistent appearance.

Heavy Duty Motorization is NOT available with Designer Cassette or Fascia options.

Battery is integrated within the motor unit.

The 12 Volt charger must be used to recharge heavy duty motors. **Solar Panel Option is NOT available for Heavy Duty Motorization.**



Spring Loaded Idler



Motorized End

### Envision Roller Shades with Heavy Duty Motorization

All standard discounts apply.

- Heavy Duty Simplicity Rechargeable Motorization: \$434.00
- 12V Charger for Heavy Duty Simplicity Rechargeable Motorization (required): \$59.00

All standard discounts apply.

#### Bracket Dimensions

Projection = 3⅝"

Width = 3"

Minimum Mounting Depth = 2"

Minimum Flush Mounting Depth = 3"

Minimum Side Mounting Depth = 3"



### Important Information about Simplicity Rechargeable Motor Shade Operation and Installation

- Simplicity Motorized Shadings installed into windows with metal casings may have a reduced radio frequency range, or may not operate at all, depending on the application.
- Do not let the antenna on the motor touch any metal objects. This may interfere with signals from the remote control.
- Be mindful of when your shade starts to slow down during operation. It is a good indicator the shade needs to be recharged. The shade will also beep when the remote button is pressed if the battery is low.

### New Solar Panel Option

Dimensions: 19" x 1½"

The new solar panel option with mounting brackets plugs into any Simplicity Rechargeable Remote control shade (does not work with PowerTouch).

The solar panel provides a constant trickle charge to 7.4v Li-Ion Rechargeable battery packs. It does not require direct sunlight, but performs best in regular direct sunlight applications.

This option prolongs the life of the charge of the 7.4v rechargeable battery packs, and in some applications will maintain charge indefinitely.

Life of charge is subject to application variables, such as size and weight of the shade, frequency of shade use, amount of direct sunlight exposure, etc.



# Color Lux® Roller Shades

## SIMPLICITY RECHARGEABLE MOTORIZATION

### Simplicity Rechargeable Motorization Remote Control Options

#### Simplicity 5 Channel Remote

The Simplicity Remote features 5 individual frequency channels and an All channel that will operate all the shades at once.

The 5 Channel Simplicity remote is available in white and black. All remotes come with a holder which can be mounted to a wall for easy storage.



The remote controls utilizes one 3V battery (CR2430). Batteries are included. Comfortex will warranty batteries for up to 3 months from date of purchase. Remote control batteries are not covered by the limited lifetime warranty.

#### Standard Simplicity Battery Operated Motorized Shades Warranty

Please see page 136 for complete Comfortex warranty information.

#### Simplicity 14 Channel Remote

The Simplicity 14 Channel remote can operate up to fourteen shades individually or 14 groups. Simplicity Rechargeable Motorized Roller Shades are programmed at the factory with the “up and down” limits. The shades are **UNLINKED** from the remote so they are not able to operate during shipping. Each shade should be installed **after** linking it to the remote.

Simplicity 14 Channel remotes and holders are white in color. The remote comes with a holder which can be mounted to a wall for easy storage. The range of the remote is approximately 80 feet. A 14 Channel (14C) remote can be utilized on all Simplicity Motorized Shades.



#### Simplicity 6 Channel Timer Remote

The 6 Channel (6C) timer remote combines the functionality of a six channel hand-held control with the convenience of a programmable timer.

- The 6C timer remote allows for different scheduled actions each day of the week.
- Manual function disables the timer and the remote then operates as a 6-channel hand held remote.

Simplicity 6C remotes and holders are white in color. The remote comes with a holder which can be mounted to a wall for easy storage. The range of the remote is approximately 80 feet.



#### THE FACTORY DOES NOT PROGRAM CHANNELS FOR SIMPLICITY RECHARGEABLE MOTORS.

The factory programs the upper and lower limits of every shade. Channel programming is completed after shade installation.

#### Please Note:

- Not all motors run at the same rate of speed.
- **REMOTES ARE NOT LINKED TO SHADES FROM THE FACTORY. SHADES MUST BE LINKED AFTER SHADE INSTALLATION.**
- Simplicity motors have a “Favorites” position setting. If the homeowner wants to set several shadings at the same intermediate position, follow instructions provided with installation manual.
- **WHEN ORDERING THE SIMPLICITY RECHARGEABLE, PLEASE ORDER THE NECESSARY BATTERY CHARGER.**

Please Note: Unused channels can be hidden

# Color Lux® Roller Shades

## COLOR LUX® HIGHLIGHTS CORNICE VALANCE WITH KEYSTONE



Highlight any element of your home décor with the Highlights Cornice Valance upgrade. This tailored, fabric wrapped 6-inch valance, available with seven returns sized from 1½" to 6", mounts over any product, either inside or outside the frame. The keystone option now allows for all fabrics to cover widths up to 216". It's the perfect solution for our Panel Track system. Highlights Valance without a keystone can be added to your roller shade order or as a stand alone product. Highlights Valance orders with a keystone are a stand alone product only.

Width In Inches

Highlights Cornice Valance	24	30	36	42	48	54	60	66	72	78	84	94	102	106	112	118	124	130	136	144	150	156	162	168	174	180	186	192	198	204	210	216
Highlights Cornice Valance (No Keystone)	96	106	116	125	137	143	150	158	164	170	177	189	Requires Keystone. See pricing below																			
Highlights Cornice Valance (with Keystone)	128	139	149	158	169	175	183	190	196	203	210	222	238	246	254	264	272	282	292	302	312	320	330	340	351	360	372	383	428	439	454	464

### Highlights Valance Specifications

**Valance Width with Keystone:** Maximum valance width is 216" for all Color Lux Roller Fabrics.

- Fabric cannot be railroaded
- Seaming is not available.
- Multiple Keystone may be required for larger widths. (ex. 216" Highlights Valance will require TWO Keystone, each 72" wide).

**Valance Height:** 6"

#### Standard Return Sizes:

- Inside Mount: None
- Outside Mount ordered with shade: 4"
- Custom Stand Alone Valance: Seven sizes are available, see chart below.

### Highlights Cornice Valance Upgrade can be ordered in three ways:

- Inside Mount WITH your shade
- Outside Mount WITH your shade
- Custom Stand Alone Valance with seven return sizes

### Highlights Ordering and Measuring Instructions Inside Mount Valance WITH Your Shade

- Inside mount valances are made without returns.
- An inside mount Highlights Valance will come with its own set of mounting brackets. In most scenarios, the valance brackets must be installed separately from the shade.
- Measure the inside width at the top of the window where the valance is to be installed. Measure in multiple spots to ensure accuracy. If there are variances, supply the smallest measurement.
- **Please Note:** The finished dimension of your inside mount bracket will be 3/16" less than your ordered width (see Figure A). Example: An inside mount valance ordered at 36" wide will be made 35 13/16".
- **Please Note:** You will need up to 3/2" of mounting depth to ensure your valance is fully recessed and flush with your window opening.

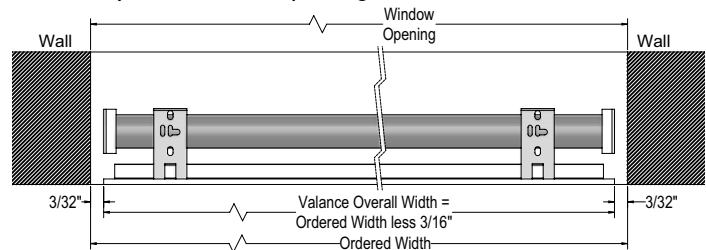

Figure A

### Mounting Information with Stand Alone Highlight Valances with Returns Size Options

Style	Return Size	Mounting Depth Required	Inside Valance Depth Clearance Provided	Comments
Inside Mount	None	3" for flush	N/A	Mounted inside window opening
Shallow Mount	1½"	1½"	7/8"	Outside Mount valance with bracket mounted inside window opening
Shallow Mount	2"	1"	1 3/8"	Outside Mount valance with bracket mounted inside window opening
Shallow Mount	2½"	½"	1 7/8"	Outside Mount valance with bracket mounted inside window opening
Outside Mount	3"	½" surface height	2 3/8"	Valance will be mounted outside window opening
Outside Mount	4"	½" surface height	3 3/8"	Valance will be mounted outside window opening
Outside Mount	5"	½" surface height	4 3/8"	Valance will be mounted outside window opening
Outside Mount	6"	½" surface height	5 3/8"	Valance will be mounted outside window opening

# Color Lux® Roller Shades

## COLOR LUX® HIGHLIGHTS CORNICE VALANCE WITH KEYSTONE

### Highlights Ordering and Measuring Instructions

#### Outside Mount Valance WITH Your Shade

- Outside mount valance will have 4" returns.
- An outside mount Highlights Valance will come with its own set of mounting brackets. In most scenarios, the valance brackets must be installed separately from the shade.
- Measure the width of the area you wish to cover. Be sure to add extra space if you have window trim or extra wall space you'd like to cover.
- **Please Note:** When ordering outside mount valances, the finished overall width of your valance will be your ordered width plus 1 1/4" (see Figures B and C).
- **Example:** An outside mount valance ordered at 36" wide will be made 37 1/4".
- **Please Note:** You will need 1/2" of surface area to mount your valance (see Figure B).

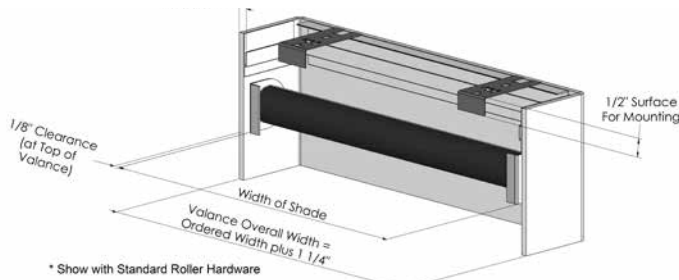

Figure B

#### Outside Mount

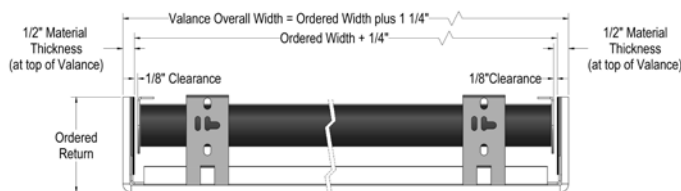

Figure C

#### Custom Stand Alone Valance with Return Size Options

- Measure the width of the area you wish to cover. Be sure to add extra space if you have window trim or extra wall space you'd like to cover. See Figures D-F for measuring information.
- Next, determine the length of your desired returns. Use the chart on page 88 for the mounting depth required and inside valance depth clearance provided for each return size.

#### Outside Mount

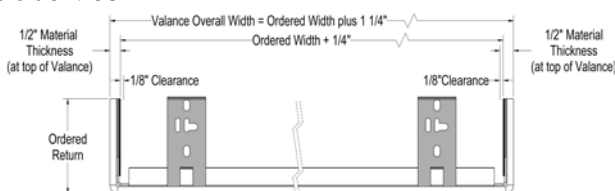

Figure D

#### Custom Stand Alone Valance with Return Size Options (Cont.)

##### Inside Mount

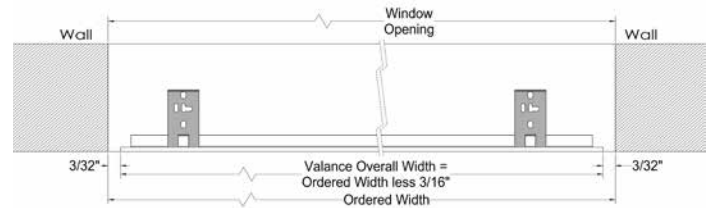

Figure E

##### Shallow Mount

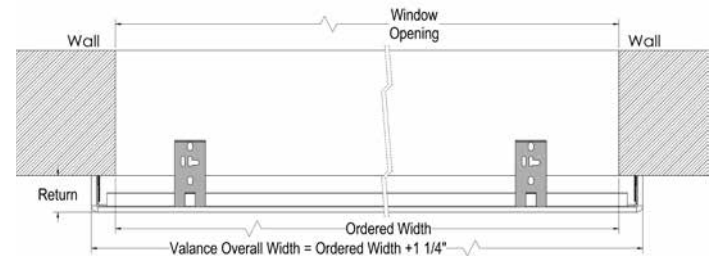

Figure F

#### Valance Returns

- Seven return size options are available when ordering a Highlights Valance as a stand alone product.
- **Return Sizes:** To determine a return length, add the component dimensions (mounting brackets, etc.) up to the wall. Subtract the measurements from any protrusions (molding, etc.), then choose from one of the pre-determined return sizes (from the chart on page 88 that best fits your application).
- **Return Coverage**  
Ordered return size refers to the distance from the face of the valance to the back of return. See Figure G.

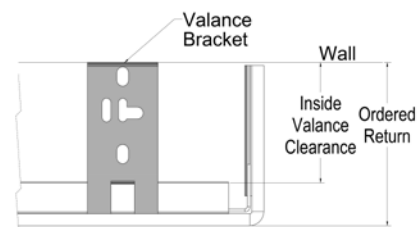

Figure G

#### Clearances

##### Shallow Mount Bracket

- 1 1/2" Return provides an inside valance clearance of 7/8".
- 2" Return provides an inside valance clearance of 1 3/8".
- 2 1/2" Return provides an inside valance clearance of 1 7/8".

##### Outside Mount Bracket

- 3" Return provides an inside valance clearance of 2 3/8".
- 4" Return provides an inside valance clearance of 3 3/8".
- 5" Return provides an inside valance clearance of 4 3/8".
- 6" Return provides an inside valance clearance of 5 3/8".

# Color Lux® Roller Shades

## COLOR LUX® HIGHLIGHTS CORNICE VALANCE WITH KEYSTONE

### Keystone Specification

- All keystones will automatically be wrapped with matching Color Lux Roller Fabric.
- Available in Classic Duck, Linen and Solar Screen 5.
- Keystones will be provided separately and installed on site.
- Ordering two optional keystones is currently not available. Two keystones may be required for some wider width valances.
- Valance panels are divided in half when the Keystone option is ordered. Custom locations for keystone placement is not available.

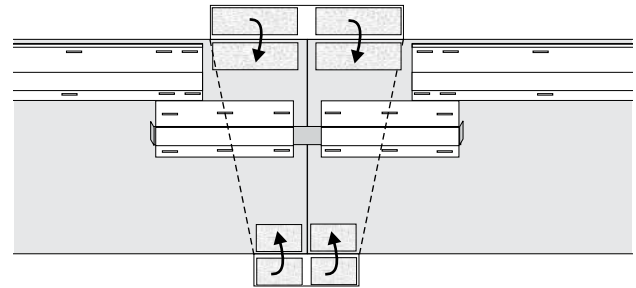

Rear view of the Highlights Valance Keystone. Not visible to room side.



Front view of the Highlights Valance Keystone.

### Keystones for Panel Tracks

- Keystones ordered for Panel Tracks should use the return sizes list below to ensure clearance of the Panel Track Rail.
- **2 Panels Side or 4 Panel Split = minimum 3" returns**
- **3 Panels Side = minimum 3" returns**
- **4 Panels Side or 6 Panel Split = minimum 4" returns**
- **5 Panels Side or 8 Panel Split = minimum 4" returns**

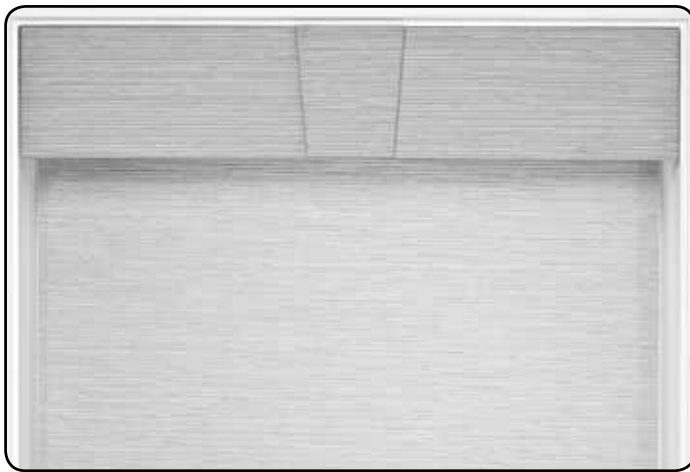

A Keystone option is available for all shade widths so every Highlights Valance in a room will be uniform

### Color Lux Custom Graphics for Highlights Cornice Valance.

Custom Graphics is available for Highlights Cornice Valance without a Keystone only.

- Available in Classic Duck Light Filtering, Classic Duck Blackout, and E - Screen 5%. (E Screen 5% is only available on Custom Graphics).
- Add 25% to Standard Rectangular Price on page 88.

## Color Lux® Fabric Cornice from Designer Window Solutions

Color Lux Designer Window Solutions now offers a beautiful new cornice option using **Color Lux Linen and Sateen Drapery** fabrics. Color Lux Fabric Cornice is NOT available with Color Lux Roller shade fabrics. Available in heights ranging from 6" to 16", with return sizes from 3" to 7", this cornice is sure to fit any application in the home. They are designed to coordinate beautifully with all Color Lux solid colors and are a perfect top treatment for other hard or soft window treatments.

**See the 2019 Color Lux Designer Window Solutions Manufacturer's Price List and Reference Guide for more information!**



Width to	24"	36"	48"	60"	72"	84"	96"	108"	120"	132"	144"	156"	168"	180"	192"	216"
	207	237	337	388	406	466	532	585	643	708	721	793	872	959	1056	1161



## COLOR LUX® PANEL TRACK SYSTEM



COLORLUX® PANEL TRACK SHADES

**COLOR LUX**  
*Designer Cellular & Roller Shades*



# Color Lux® Panel Track Shades

## SYSTEM FEATURES & OPTIONS

The Color Lux Panel Track Shade system offers versatility and a beautiful modern design for effective light control and outstanding performance. Panel track systems are a beautiful option for large windows and room dividers. Available in Classic Duck and Linen Light Filtering and Blackout, and Solar Screen 5.

### Stacking Options

Color Lux Panel Track Shades are available with 3 stacking configurations: split, left and right stacks.

- Split stack panels draw open to both sides equally. Controls may be placed on either side and is only available in cord control.
- Side stack is available as left or right stack and is available with a white wand or cord control.



Split Stack



Left or Right Stack



Closed Side Stack

### Panel Attachment

A hook and loop strip is sewn onto every panel to provide a secure attachment. The patented panel attach method makes it easy to attach the panels even after installation of the rail.

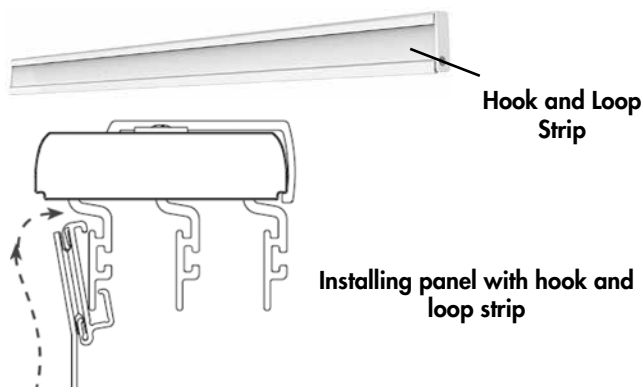

### Head Rail Colors

Select from the white or aluminum system hardware system. (Wand is always white.)



White Head Rail



Aluminum Head Rail

### Bottom Rail

Panel track bottom rails are designed for smooth operation and allows all panels to glide smoothly past each other.

- Bottom rails are designed to match perfectly with the head rail in exposed white or silver.
- Finished bottom rails will be 1/2" higher than measured drop on inside mount shades.
- Bottom rails are not connected to each other on this panel track system.
- Fabric Wrapped bottom rails are available as an option.



Fabric Wrapped Bottom Rail

### Fabric Panels and Custom Overlaps

Classic Duck Light Filtering and Blackout are both available with the Color Lux Panel Track Shade System.

- Panels will be fabricated with a 2" overlap as standard. Custom overlaps are available at 1 1/2", 2 1/2" and 3". Please specify when ordering.
- Panels are attached with a hook and loop strip to allow for subtle fabric adjustment in the field.
- Each panel traverses the track using ball bearings, creating smooth operation for wand and cord control
- Panels follow a single lead panel in sequence to open and close.
- Panels position exactly behind one another in the open position.
- There is no light gap between the rail and the panels.
- Panels will reach the end of the track.

**Please Note:** Panels may not hang perfectly flat immediately upon installation. Panels may have a billowing or wavy appearance at the time of installation which may correct itself over time.

Replacement panels are available.

# Color Lux® Panel Track Shades

## SYSTEM FEATURES & OPTIONS

### Control Options

The panel track system uses a cord or wand for traversing the fabric panels. Cord control is standard with every panel track shade. Wand control is available at no additional surcharge. Please specify when ordering.

#### Cord Control

- The nylon cord is white or grey to coordinate with hardware.
- Standard length of the cord is 10" less the ordered length. Custom cord lengths are available. Please specify when ordering.
- Standard cord placement is right stack with right cord.
- Operating cords are located on the outside edge of the panels.
- Tensioner for cord control is always white.
- Tensioner must always be placed so the cord reaches full extension.



Grey Cord Control

#### Wand Control

The traversing wand is a convenient alternative to a traditional cord control. This single control system protects children and pets from injuries caused by loop cords.



White Wand Control

- The wand control is always white.
- Only available on side stack systems.
- Standard wand placement is on the outside leading edge of the left or right stack.

#### Standard Wand Lengths

- Shades up to 72" in Length: 36" wand
- 72" to 96" in Length: 48" wand
- 96" to 120" in Length: 60" wand
- 120" to 144" in Length: 72" wand

Custom lengths are not available but you may select from one of the standard wand lengths above.

### Panel Widths

To achieve the best performance on this panel track system, panels are designed within the following parameters:

- The minimum width for a single panel is 6".**
- The maximum width for a single panel is 48".**
- The maximum panel height is 144".**

See price grids for the minimum number of panels that will be available at the desired width.

More panels can be ordered at an additional surcharge and to achieve the desired panel width.

The standard panel overlap is 2". Custom overlaps are available.

**Example:** The standard split stack on a 96" wide opening would have 4 panels at 26" wide with a 2" overlap. If 6 panels are desired, each panel would be 18" wide.

### Track Specifications

- The minimum width of a track is 18".**
- The maximum width of a track is 216".**

The maximum width of a single panel track is 216". When the total width is ordered over 100", tracks will be split in half and a connector bracket will be provided.

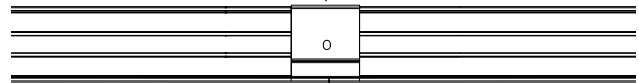

### Panel Stack Back

The stack back will be equal to a single panel width. It will never be less than 12" and never exceed 48".

#### To determine an approximate stack back:

Ordered Width ÷ Number of Panels = Stack Back within +/- 2". (with 2" standard overlap)

### Color Lux Custom Graphics for Panel Track

Custom Graphics is available on Panel Track Shades in the following fabrics:

- Classic Duck Light Filtering
- Classic Duck Blackout
- E Screen 5% (only available for Custom Graphics)

Add 25% to Standard Rectangular price plus desired upgrades.

**Color Lux® Panel Track Shades**

**GRID #22**

Classic Duck Light Filtering    Linen Light Filtering    Solar Screen 5  
 Classic Duck Blackout    Linen Blackout

Center Split Stack  
 Standard Cord Draw

Standard # of Panels	Panel Width										
	11"	14"	17"	20"	26"	32"	38"	44"	34"	38"	
Width In Inches											
	36	48	60	72	96	120	144	168	192	216	
Length in Inches	48	699	803	851	956	1171	1335	1551	1704	1814	1920
	60	716	824	873	981	1201	1369	1593	1749	1863	1971
	72	733	844	891	1004	1232	1402	1634	1794	1911	2022
	84	749	864	911	1027	1262	1436	1675	1838	1959	2073
	96	767	884	932	1051	1293	1472	1717	1885	2008	2123
	108	782	906	953	1075	1323	1507	1757	1928	2056	2175
	120	800	925	972	1099	1355	1541	1799	1974	2105	2225
	132	817	946	1029	1124	1385	1613	1840	2056	2191	2316
144	834	966	1054	1147	1416	1651	1883	2105	2243	2371	

Surcharge for Additional Panels										
6 Panels	—	—	34	45	59	72	86	99	—	—
8 Panels	—	—	—	—	118	146	172	197	120	134

Panel Width (Inches) (Approximate*)										
6 Panels	—	—	10"	12"	16"	20"	24"	28"	—	—
8 Panels	—	—	—	—	12"	15"	18"	21"	24"	27"

\* Measurements do not account for standard deductions to fabric and head rail and use standard 2" overlap.

**GRID #23 One Way Side Stack  
 Standard Cord Draw**

Standard # of Panels	Panel Width										
	20"	26"	32"	38"	34"	42"	38"	44"	40"	43"	
Width In Inches											
	36	48	60	72	96	120	144	168	192	216	
Length in Inches	48	699	803	851	956	1171	1335	1551	1704	1814	1920
	60	716	824	873	981	1201	1369	1593	1749	1863	1971
	72	733	844	891	1004	1232	1402	1634	1794	1911	2022
	84	749	864	911	1027	1262	1436	1675	1838	1959	2073
	96	767	884	932	1051	1293	1472	1717	1885	2008	2123
	108	782	906	953	1075	1323	1507	1757	1928	2056	2175
	120	800	925	972	1099	1355	1541	1799	1974	2105	2225
	132	817	946	1029	1124	1385	1613	1840	2056	2191	2316
144	834	966	1054	1147	1416	1651	1883	2105	2243	2371	

Surcharge for Additional Panels										
3 Panels	24	30	40	45	—	—	—	—	—	—
4 Panels	—	61	81	91	118	74	—	—	—	—
5 Panels	—	—	161	183	235	148	181	110	—	—

Panel Width (Inches) (Approximate*)										
3 Panels	12"	16"	20"	24"	—	—	—	—	—	—
4 Panels	—	12"	15"	18"	24"	30"	—	—	—	—
5 Panels	—	—	12"	14"	19"	26"	29"	34"	—	—

\* Measurements do not account for standard deductions to fabric and head rail and use standard 2" overlap.

**Additional Surcharges**

Scotchgard™ Stain Protection	Add \$50 to the standard rectangular price.
------------------------------	---

**Product Specifications**

**Head Rail Options**

- White
- Aluminum

**Bottom Rail Options**

- White
- Aluminum

**Control Options**

- Cord Draw (standard)
- Wand Draw (wand is always white)

**Panel Size**

- Minimum panel width is 6"
- Maximum panel width is 48"

# Color Lux® Panel Track Shades

## SPECIFICATIONS

Panel Track Finished Dimensions				
	Inside Mount - Cord Draw	Inside Mount - Wand Draw	Outside Mount - Cord Draw	Outside Mount - Wand Draw
<b>Width of Finished Panel Coverage</b>	Ordered Width minus 5/8"	Ordered Width minus 5/8"	Ordered Width minus 3/8"	Ordered Width minus 3/8"
<b>Track</b>	Ordered Width minus 1/4"	Ordered Width minus 1/4"	Ordered Width	Ordered Width
<b>Length</b>	Ordered Length minus 1/2"	Ordered Length minus 1/2"	Ordered Length	Ordered Length

### Mounting Options

The following mounting options are available. All mounting brackets are coordinated with the head rail in white or aluminum:

- Wall Bracket with End Caps
- Ceiling Bracket with End Caps

### Light Gap

**Head Rail/Fabric Panels:** There is no light gap between the fabric panels and the bottom of the head rail.

**Outside Mount Bracket/Head Rail:** There is a 1/4" light gap between the top of the track to the top of the outside mount installation bracket.

**Inside Mount Bracket/Head Rail:** There is a 1/8" gap between the top of the track to the top of the inside mount installation bracket.

**Bottom Light Gap:** There will be a 1/2" light gap at the bottom of the hanging panels on an inside mount shade.

**Side Light Gap:** There will be 3/16" side light gap at the sides of the panel track.

To avoid side light gap on outside mount shades, Comfortex recommends increasing the ordered width by 5", or 2 1/2" on both sides.

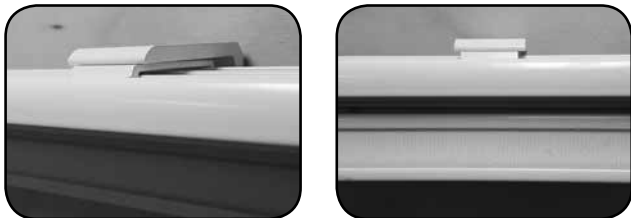

Outside Mount Installation Bracket Appearance

### Fabric Deductions and Specifications

Panels are fabricated with a 2" overlap as standard. Custom overlaps are available in 1 1/2", 2 1/2" or 3".

#### Inside Mount:

Head rail width = ordered width minus 1/4"

Panel height allowance = ordered length minus 1/2"

#### Outside Mount:

No additional deductions are taken for fabric width

Panel height allowance = ordered length

### Highlights Valance for Panel Track with Keystone

See pages 88 - 90 for more information on the Color Lux Highlights Cornice Valance for your Panel Track system.

- Keystones ordered for Panel Tracks should use return sizes list below to ensure clearance of the Panel Track Rail.
- **2 Panels Side or 4 Panel Split = minimum 3" returns**
- **3 Panels Side = minimum 3" returns**
- **4 Panels Side or 6 Panel Split = minimum 4" returns**
- **5 Panels Side or 8 Panel Split = minimum 4" returns**
- Keystones automatically match the color and fabric of the ordered Color Lux Highlights Valance. Custom color options are not available.
- Valance panels are divided in half when the Keystone option is ordered. Custom locations for keystone placement is not available.
- Ordering two optional keystones is currently not available.
- Multiple Keystones may be required for larger widths. (ex. A Highlights Valance with an ordered width of 216" will require TWO Keystone. All three valances will be 72" wide, excluding returns).
- The front panel on a split stack will overlap the back panel as illustrated on page 96.

### Highlights Cornice Valance with Keystone for Panel Track Shades

Highlights Cornice Valance	24	30	36	42	48	54	60	66	72	78	84	94	102	106	112	118	124	130	136	144	150	156	162	168	174	180	186	192	198	204	210	216
Highlights Cornice Valance (No Keystone)	96	106	116	125	137	143	150	158	164	170	177	189	Requires Keystone. See pricing below																			
Highlights Cornice Valance (with Keystone)	128	139	149	158	169	175	183	190	196	203	210	222	238	246	254	264	272	282	292	302	312	320	330	340	351	360	372	383	428	439	454	464

# Color Lux® Panel Track Shades

## SPECIFICATIONS

### Clear Window Opening

Panel Tracks are an excellent option for clearing a window opening. Please see the below charts for guidance on what ordered width is recommended to clear a window opening.

#### For Example:

For a One Way Side Stack ordered with 5 panels, in order to clear an opening of 94", the ordered width of the panel track should be 120".

### One Way Side Stack Panel Track

Step 1: Select # of Panels

Step 2: Select uncovered width

<b>2 Panels</b>	If uncovered width is	17	23	29	35	-	-	-	-	-	-
<b>3 Panels</b>	If uncovered width is	23	31	39	47	63	79	-	-	-	-
<b>4 Panels</b>	If uncovered width is	25	34	43	52	70	88	106	124	-	-
<b>5 Panels</b>	If uncovered width is	27	37	47	56	75	94	113	133	152	171
<b>Result: Then Ordered Width is</b>		<b>36</b>	<b>48</b>	<b>60</b>	<b>72</b>	<b>96</b>	<b>120</b>	<b>144</b>	<b>168</b>	<b>192</b>	<b>216</b>

### Split Stack Panel Track

Step 1: Select # of Panels

Step 2: Select uncovered width

<b>4 Panels</b>	If uncovered width is	25	34	43	52	70	88	106	124	-	-
<b>6 Panels</b>	If uncovered width is	28	38	48	58	78	98	118	138	158	178
<b>8 Panels</b>	If uncovered width is	30	40	51	61	82	103	124	145	166	187
<b>Result: Then Ordered Width is</b>		<b>36</b>	<b>48</b>	<b>60</b>	<b>72</b>	<b>96</b>	<b>120</b>	<b>144</b>	<b>168</b>	<b>192</b>	<b>216</b>

### Panel Configuration - Wand and Cord Control

The lead panel is always in front and catches the panels behind it. Right stack and split stack panel configuration is shown below.

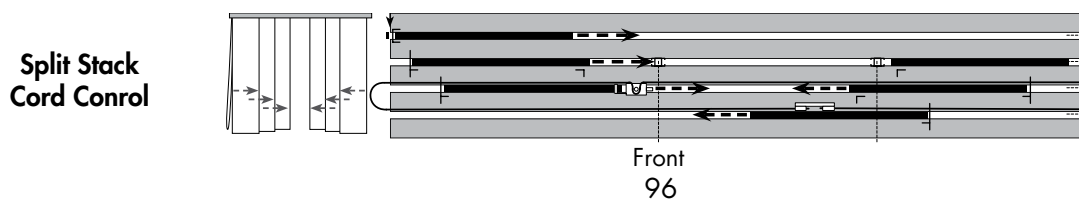
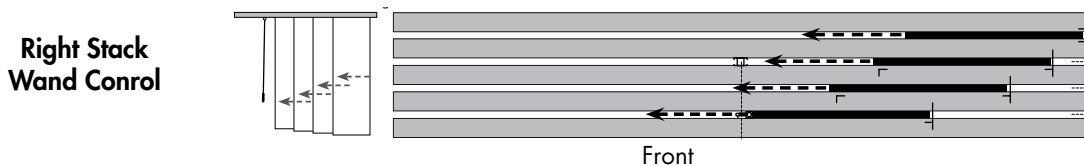

# Color Lux® Panel Track Shades

## SPECIFICATIONS

### Outside Mount Hardware Profiles

Five separate panel track profiles are available depending on the number of panels ordered.

#### Two Track System

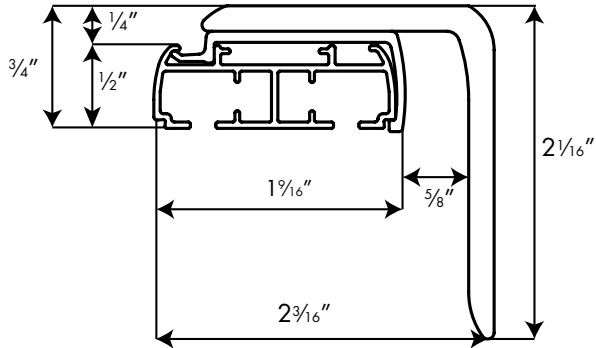

Two channel tracks are used for:  
2 panel side stack  
4 panel split stack

#### Mounting Dimensions

Minimum height required for outside mounting: 2 1/16"  
Extension Bracket projects back of bracket 2 5/8" from wall

#### Three Track System

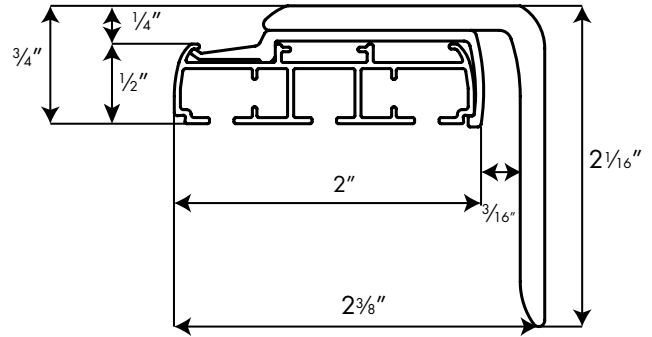

Three channel tracks are used for:  
3 panel side stack  
Not Available for split stack

#### Mounting Dimensions

Minimum height required for outside mounting: 2 1/16"  
Extension Bracket projects back of bracket 2 3/16" from wall

#### Four Track System

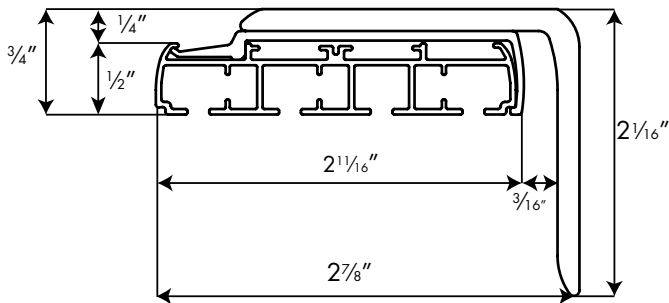

Four channel tracks are used for:  
4 panel side stack  
6 panel split stack

#### Mounting Dimensions

Minimum height required for outside mounting: 2 1/16"  
Extension Bracket projects back of bracket 1 9/16" from wall

#### Five Track System

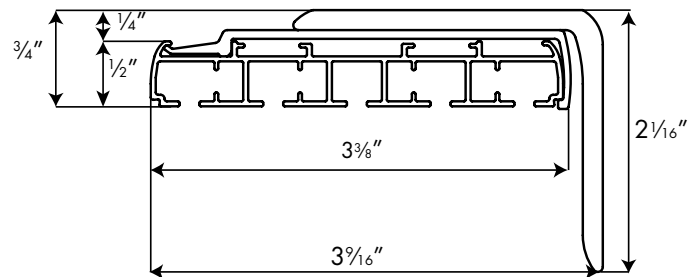

Five channel tracks are used for:  
5 panel side stack  
8 panel split stack

#### Mounting Dimensions

Minimum height required for outside mounting: 2 1/16"  
Extension Bracket projects back of bracket 1 7/16" from wall

For outside mount brackets, Spacer blocks are available at 1/16" increments, up to two. Add to overall projection.  
Example: For a four panel track, take 2 7/8" plus 1/16"



# Color Lux® Panel Track Shades

## SPECIFICATIONS

### Inside Mount Hardware Profiles

Five separate panel track profiles are available depending on the number of panels ordered.

#### Two Track System

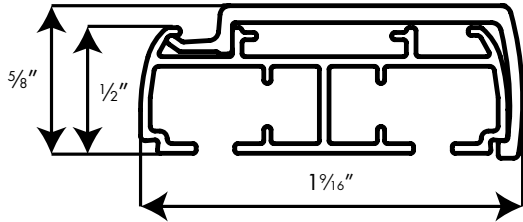

Two channel tracks are used for:  
 2 panel side stack  
 4 panel split stack

#### Mounting Dimensions

Minimum depth for flush inside mount: 1 1/16"  
 Minimum depth required for shallow mounting: 1 1/4"

#### Three Track System

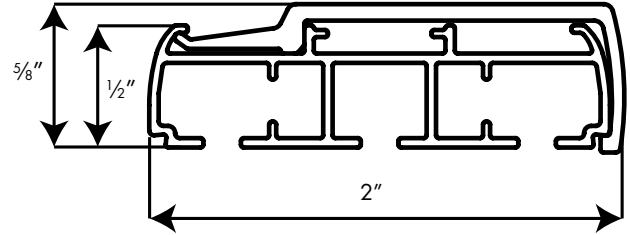

Three channel tracks are used for:  
 3 panel side stack  
 Not available for split stack

#### Mounting Dimensions

Minimum depth for flush inside mount: 2"  
 Minimum depth required for shallow mounting: 1 7/16"

#### Four Track System

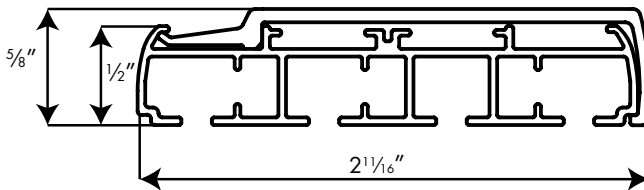

Four channel tracks are used for:  
 4 panel side stack  
 6 panel split stack

#### Mounting Dimensions

Minimum depth for flush inside mount: 2 1/16"  
 Minimum depth required for shallow mounting: 2 1/16"

#### Five Track System

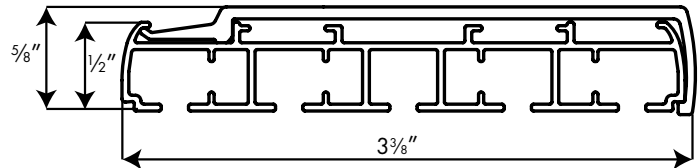

Five channel tracks are used for:  
 5 panel side stack  
 8 panel split stack

#### Mounting Dimensions

Minimum depth for flush inside mount: 3 3/8"  
 Minimum depth required for shallow mounting: 2 1/4"

# COLOR LUX®

*Custom Graphics*



# Color Lux® Custom Graphic Shades

## FEATURES & GENERAL INFORMATION

**Print Photos, Logos, Artwork, Advertisements and More on Color Lux® Roller and Panel Track Shades!**  
 With Color Lux® Custom Graphics you can print literally anything on a Color Lux® Roller or Panel Track Shade. From logos and advertisements for a store front, to personal photos and theme room graphics, virtually anything you imagine can be featured on a Color Lux® Roller or Panel Track Shade.

Color Lux® Custom Graphics are also available on Cellular Shades. See the **Comfortex Cellular Shade Collection Manufacturer's Price List and Reference Guide** for more information.



**Side A**  
Shows Printed Image

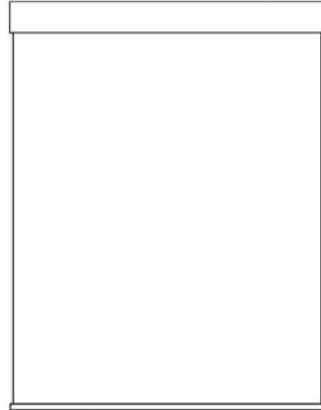

**Side B**  
White Fabric

### Single Sided Printing:

- Select a Roller or Panel Track Shade.
- Color Lux® Roller Custom Graphics Shades are available on Classic Duck Light Filtering, Classic Duck Blackout and Mermet E Screen 5%
- (E Screen 5% is only available with Custom Graphic Shades)
- Use the Color Lux Custom Graphics Grids on pages 102 and 103.
- A Color Lux® solid color may be selected for the background color of your shade.
- You can choose to have Side A face the room side or the street side.
- Use the Color Lux® Custom Graphics Order Form

**Please Note:** When ordering a Color Lux® Panel Track System Shade with a custom graphic, the custom graphic will not line up. The fabric used on Color Lux® Panel Track Shades will be printed at the total width and length specified for the complete system and then will be cut into the number of panels specified. **The pattern on the adjacent panels will overlap by 1½”.**



**Side A**  
Shows Printed Image

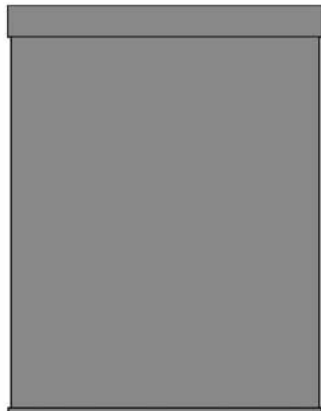

**Side B**  
Solid Printed Color ONLY  
(No Graphics)

### Double Sided Printing -

#### Roller Shades on Mermet E Screen 5% Only:

- Double sided printing is available only with Roller Shades.
- Double sided printing is only available on Mermet E Screen 5% Fabric.
- Add the 40% Surcharge to the Standard Rectangular price found on page 103 plus desired hardware options.
- Side A can be any custom graphic.
- Side B can only be a Color Lux® solid color (NO GRAPHICS).
- You can choose to have Side A face the room side or the street side.
- A Color Lux® solid color may be selected for the background color of your shade.
- Use the Color Lux® Custom Graphics Roller Shade Order Forms.

# Color Lux® Custom Graphic Shades

## FEATURES & GENERAL INFORMATION

### How to order Color Lux® Custom Graphic Shades

#### STEP 1. FAX OR E-MAIL YOUR ORDER

Fax the appropriate Color Lux® Custom Graphics order form (Roller, Panel Track or Cellular) located on [comfortex.com/comfortex-dealers](http://comfortex.com/comfortex-dealers) to (800) 336-4580. Or e-mail the order form to [customercare@comfortex.com](mailto:customercare@comfortex.com). Upon receipt and review of your order, you will receive a work order confirmation number from Comfortex. Please be sure to reference this number when submitting your artwork in Step 2.

#### STEP 2. SOURCE AND SEND YOUR GRAPHIC

Source your graphic from a stock photo site such as [www.istockphoto.com](http://www.istockphoto.com) or use your own high resolution photography. Send your files via e-mail to: [customgraphics@comfortex.com](mailto:customgraphics@comfortex.com) OR ship a CD/portable media containing your graphics to:

Color Lux® Custom Graphics  
 Comfortex Window Fashions  
 21 Elm Street  
 Maplewood, New York 12189

#### Using Online Stock Agencies for Graphics for Your Shades

Sometimes, finding the right graphic or photograph to fit your shade size, shape, or content can be challenging. Fortunately, many web sites offer a great solution. Online stock agencies allow you to purchase reasonably priced, royalty-free digital illustrations, graphics, photographs, patterns, and more in thousands of different subject areas. Some of the more popular sites include:

- [thinkstock.com](http://thinkstock.com)
- [istockphoto.com](http://istockphoto.com)
- [veer.com](http://veer.com)
- [shutterstock.com](http://shutterstock.com)
- [gettyimages.com](http://gettyimages.com)
- [123rf.com](http://123rf.com)
- [photosearch.com](http://photosearch.com)

#### Using these sites is easy, simply follow these steps:

Step 1. Create an account and search for your image (i.e. apples).

Step 2. Select, purchase, and download the image you like. You may be given a choice of sizes, so take care to select an option large enough for your needs. Be sure to include the Work Order Confirmation Number received from Comfortex Customer Service with your graphic files.

#### STEP 3. APPROVE YOUR PROOF

The Color Lux® Custom Graphic Team will email a PDF proof of your shade order which must be reviewed and approved for production to begin. Once the artwork is approved, it will take 2 weeks for your order to be printed, assembled, and shipped.

#### Color Lux® Graphic File Specifications Preferred Formats

- Vector files/Adobe Illustrator (AI or EPS)  
Please convert all typography to paths prior to submitting your vector artwork.
- TIFF, JPG/JPEG, or Adobe Photoshop (PSD) files with a minimum resolution of 100 pixels per inch at 100% size. For example, a shade measuring 30" x 40" should be supported by a graphic measuring at least 3000 x 4000 pixels.
- Adobe Acrobat (PDF) files created in "Press Quality" or "High Quality Print" with a minimum resolution for all raster elements of 100 pixels per inch at 100% size.

Graphics optimized for, or harvested from the internet are, in general, not suitable for reproduction onto shades.

Comfortex will seek to verify ownership and rights to reprint for all images showcasing copyrighted material.

**Questions?** Please contact Comfortex Customer Care with all questions regarding Color Lux® Custom Graphic Orders.

### E Screen 5% Fabric Properties

Mermet E Screen 5%	TS	RS	AS	TV	OF	SHGC/G Value		Fire Rating	Bacterial & Fungal Resistance	Acoustical Properties	RoHS
						CL - S	DG				
Composition: 36% Fiberglass, 64% Vinyl Width: 98" Weight: 363 g/m <sup>2</sup> ± 5% Thickness: 0.41 mm ± 5% UV Blockage: 90%	20	71	9	17	5.00	0.32	0.34	NFPA 701-10 TM#1, California U.S. Title 19	ASTM E2180 ASTM G21	NRC: 0.10 SAA: .012	✓

Color Lux Custom Graphics  
Skyline Standard Roller Shade

**GRID 24** Classic Duck Light Filtering

		Width In Inches																					
		24	30	36	42	48	54	60	66	72	78	84	90	96	102	106	112	118	124	130	136	144	
Length In Inches	36	285	316	351	390	434	480	534	601	668	749	853	939	1011	1093	1179	1205	1435	1566	1709	1869	2039	
	42	291	325	360	401	445	494	548	619	688	769	874	961	1038	1123	1211	1235	1474	1608	1759	1916	2096	
	48	301	334	371	413	458	509	561	634	705	789	898	988	1066	1151	1244	1268	1513	1650	1803	1969	2148	
	54	311	341	379	421	468	518	578	650	723	808	921	1011	1095	1183	1276	1303	1551	1694	1848	2019	2205	
	60	316	351	390	433	480	533	591	668	743	830	943	1036	1120	1209	1305	1331	1589	1735	1896	2068	2230	
	66	325	359	400	443	493	546	605	681	758	849	964	1064	1146	1239	1339	1368	1629	1778	1940	2120	2260	
	72	331	370	408	456	504	558	620	700	778	870	990	1086	1176	1268	1373	1398	1668	1821	1985	2171	2294	
	78	340	376	420	464	514	571	634	716	794	893	1011	1111	1201	1299	1400	1431	1706	1861	2033	2180	2491	
	84	348	385	426	473	526	586	650	730	814	910	1035	1140	1230	1329	1433	1463	1744	1905	1963	2186	2566	
	90	356	394	438	485	539	598	663	749	831	931	1056	1163	1258	1381	1479	1495	1783	1948	2006	2205	2644	
	96	363	403	446	499	551	610	676	766	846	950	1081	1190	1284	1440	1515	1528	1823	1989	2049	2459	2724	
	102	375	416	460	511	566	630	700	789	876	971	1105	1215	1311	1478	1546	1573	1878	2049	2289	2533	2805	
	108	381	424	471	520	580	643	713	804	895	991	1126	1239	1339	1486	1596	1620	1934	2110	2358	2609	2889	
	114	389	431	478	531	591	656	728	821	913	1011	1151	1264	1369	1521	1643							
	120	398	441	490	544	604	669	743	838	931	1031	1173	1291	1394	1546	1704							
	126	405	450	500	556	614	683	756	854	949	1053	1196	1315	1425	1581	1726							
132	416	460	511	566	628	699	773	871	968	1074	1220	1341	1451	1613	1823								
138	424	469	519	578	639	711	788	888	988	1095	1244	1370	1479	1638	1855								
144	431	476	529	590	651	725	803	906	1006	1114	1268	1396	1511	1703	1905								

**Classic Duck Light Filtering:** Minimum standard shade size is 12" x 12". Maximum shade width is 106" and it can be railroaded to a maximum width of 144" and a maximum length of 108". Double sided printing is not available.

**GRID 25** Classic Duck Blackout

Color Lux Custom Graphics  
Skyline Standard Roller Shade

		Width In Inches																					
		24	30	36	42	48	54	60	66	72	78	84	90	96	102	106	112	118	124	130	136	144	
Length In Inches	36	316	351	390	433	481	534	593	668	743	833	945	1043	1121	1213	1308	1338	1593	1740	1899	2075	2261	
	42	324	360	400	445	495	549	609	688	763	855	970	1068	1153	1246	1344	1373	1636	1784	1953	2126	2328	
	48	334	370	414	458	508	565	624	704	783	876	995	1095	1184	1279	1381	1409	1678	1833	2001	2184	2386	
	54	346	379	420	468	520	576	640	721	801	898	1024	1121	1216	1313	1416	1449	1723	1880	2051	2240	2544	
	60	351	390	433	480	534	591	656	743	824	921	1046	1150	1243	1341	1450	1478	1764	1926	2104	2295	2713	
	66	360	399	444	493	546	605	673	756	841	944	1071	1180	1273	1375	1486	1516	1811	1973	2153	2446	2891	
	72	369	413	455	506	558	620	689	776	863	964	1100	1205	1304	1409	1524	1550	1850	2021	2204	2609	3083	
	78	378	418	466	514	571	634	704	796	883	990	1121	1234	1334	1440	1554	1589	1895	2068	2350	2781	3286	
	84	385	428	473	525	584	650	721	811	903	1010	1149	1265	1368	1473	1590	1624	1936	2114	2505	2964	3503	
	90	396	438	485	539	598	664	735	831	924	1033	1173	1291	1395	1534	1644	1660	1981	2253	2671	3159	3734	
	96	403	446	498	553	613	676	750	849	940	1054	1200	1321	1426	1600	1683	1695	2024	2401	2848	3368	3980	
	102	418	461	511	568	629	700	778	876	974	1153	1313	1441	1558	1755	1836	1934	2309	2739	3249	3841	4541	
	108	423	471	521	578	644	713	791	894	993	1178	1340	1471	1590	1765	1896	2061	2461	2920	3464	4095	4841	
	114	433	478	530	590	656	728	808	911	1013	1121	1279	1401	1518	1689	1821							
	120	441	490	544	604	670	743	824	931	1033	1145	1301	1433	1548	1716	1891							
	126	450	500	555	618	681	758	839	948	1053	1169	1329	1460	1581	1755	1915							
132	461	511	568	629	696	775	858	966	1074	1191	1354	1490	1610	1790	1954								
138	471	519	576	641	710	790	875	988	1095	1216	1381	1520	1644	1818	1993								
144	478	529	588	655	724	805	893	1006	1116	1238	1409	1550	1678	1890	2033								

**Classic Duck Blackout:** Minimum standard shade size is 12" x 12". Maximum shade width is 106" and it can be railroaded to a maximum width of 144" and a maximum length of 108". Double sided printing is not available.

**Color Lux Custom Graphics for Panel Track Shades**

Available on Classic Duck Light Filtering, Classic Duck Blackout, and E-Screen 5% (E - Screen is only available with Custom Graphics shades) See page 94 for price grids. Add 25% to Standard Rectangular price plus desired upgrades.

**Color Lux Custom Graphics for Highlights Valance**

Not available with the Keystone Option. Available on Classic Duck Light Filtering, Classic Duck Blackout, and E-Screen 5% (E - Screen is only available with Custom Graphics shades). See page 88 for price grids. Add 25% to Standard Rectangular price.



**Color Lux Custom Graphics  
Skyline Standard Roller Shade**

COLORLUX® CUSTOM GRAPHICS

		Width In Inches																				
		24	30	36	42	48	54	60	66	72	78	84	90	96	102	108	112	118	124	130	136	144
Length In Inches	36	351	390	433	480	534	592	658	741	824	924	1049	1157	1245	1346	1451	1485	1768	1931	2108	2303	2510
	42	359	400	444	494	549	609	676	763	846	949	1077	1185	1279	1383	1492	1523	1816	1980	2167	2360	2584
	48	370	411	459	508	563	627	692	781	869	973	1104	1215	1314	1419	1533	1564	1862	2034	2221	2424	2649
	54	384	420	466	519	577	640	710	801	889	996	1136	1245	1350	1457	1572	1608	1912	2087	2277	2486	2824
	60	390	433	480	533	592	656	728	824	914	1023	1161	1277	1379	1489	1610	1640	1958	2138	2335	2547	3011
	66	400	443	493	547	606	672	746	839	934	1048	1189	1310	1412	1526	1650	1683	2010	2189	2389	2715	3209
	72	409	458	505	562	619	688	765	862	957	1070	1221	1338	1447	1564	1691	1721	2054	2244	2446	2896	3422
	78	419	463	518	570	634	703	781	884	980	1099	1245	1369	1480	1598	1725	1764	2103	2295	2609	3087	3648
	84	427	475	524	583	648	722	801	900	1002	1121	1275	1404	1518	1634	1765	1802	2149	2346	2781	3290	3888
	90	440	486	538	598	663	737	816	923	1025	1146	1301	1433	1548	1702	1825	1843	2199	2500	2965	3506	4144
	96	447	495	552	613	680	751	833	942	1043	1170	1332	1467	1583	1776	1868	1881	2246	2665	3161	3738	4418
	102	463	512	567	630	698	777	863	973	1081	1279	1457	1600	1729	1948	2038	2146	2563	3040	3606	4264	5041
	108	469	523	579	641	715	791	878	992	1102	1307	1487	1633	1765	1959	2105	2288	2732	3241	3845	4545	5374
	114	480	530	588	655	728	808	896	1011	1124	1245	1419	1555	1684	1875	2022						
120	490	544	604	670	744	824	914	1034	1146	1271	1444	1590	1718	1905	2099							
126	500	555	616	685	756	841	931	1052	1168	1297	1475	1621	1755	1948	2126							
132	512	567	630	698	773	860	952	1073	1192	1322	1503	1654	1787	1987	2169							
138	523	576	640	712	788	877	971	1096	1215	1350	1533	1687	1825	2017	2212							
144	530	587	652	727	803	894	991	1117	1239	1374	1564	1721	1862	2098								

**Mermet 5% E Screen:** Minimum standard shade size is 12" x 12". Maximum shade width is 120" and can be railroaded to a maximum width of 144" with a maximum length of 108". Mermet 5% E Screen is only available for Color Lux Custom Graphics shades. Double Sided printing is only available on Mermet 5% E Screen.

**Head Rail Options and Surcharges**

Section 1 & 2	Available: Designer Cassette (All), Cordless Deco-Bar, Fascia (All), Motorization, PowerTouch Rechargeable, Standard Roller, and All Skyline Hardware
Section 3	Available: Standard Roller, Standard Skyline Roller, 4" Fascia, and 4" Skyline Fascia with Cord Loop (Dual Roller Not Available)
Section 4	Available: Standard Skyline Roller Only (Dual Roller Not Available)

**Roller Only Options**

Skyline Clutch (White, Ivory, Black)	No Additional Surcharge
Skyline Clutch (Satin Nickel and Bronze)	\$28
Skyline Dual Roller (Price two separate shades, then add surcharge)	\$28
Cordless with White, Ivory and Black Deco-Bar	\$42
Cordless with Bronze and Satin Nickel Deco-Bar	\$63
Spring Assist for Shades over 84" x 84" (White or Black Clutch)	\$130

**Designer Cassette and Fascia Options**

	24	30	36	42	48	54	60	66	72	78	84	90	96	102	108	114	120
White, Ivory, Black, Satin Nickel, and Oil Rubbed Bronze Includes Smooth Face and Insert Strip/rap	78	84	90	97	103	111	119	126	133	128	135	147	152	156	162	185	208
4" Skyline Fascia	64	70	72	74	84	97	106	117	128	137	149	162	169	179	191	201	210
Cordless with Cassette	Add \$42 PLUS the Designer Cassette Surcharge																
Retractable Cord with Designer Cassette	Add \$42 PLUS the Designer Cassette Surcharge																

**Highlights Cornice Valance**

	24	30	36	42	48	54	60	66	72	78	84	94	102	106	112	118	124	130	136	144
Highlights Cornice Valance (No Keystone)	96	106	116	125	137	143	150	158	164	170	177	189	Requires Keystone. See pricing below							
Highlights Cornice Valance (with Keystone)	128	139	149	158	169	175	183	190	196	203	210	222	238	246	254	264	272	282	292	302

**Motorization: Available with Designer Cassette, 4" Skyline Fascia, and Standard Roller**

	Reference
PowerTouch Rechargeable	\$118 per shade pg. 83
Simplicity Wave	\$121 per shade pg. 80
Simplicity Rechargeable Motorization	\$319 per shade pg. 85
Simplicity Rechargeable Heavy Duty Motorization	\$434 per shade pg. 86
Simplicity 5 Channel Remote	\$41 per remote pg. 87
Simplicity 6 Channel Timer Remote	\$67 per remote pg. 87
Simplicity 14 Channel Remote	\$67 per remote pg. 87
Simplicity Smart Controller	\$336 per controller pg. 30
Solar Panel	\$105 per panel pg. 86
Telescoping Wand for Simplicity Wave	\$32 per wand pg. 80
Charger for Simplicity Rechargeable Motor	\$28 per charger pg. 85
Charger for Heavy Duty Rechargeable Motor	\$59 per charger pg. 86

**Cordless Specifications for All Custom Graphics Fabrics:**

Minimum width is 15½";  
Maximum Width is 96";  
Maximum Length is 96"

**Tube Information for Clutch Operated Shades Only**

- **Section 1:** Shades to the left of the dashed line requires a 1" tube/SL10" clutch
- **Section 2:** Shades to the right of the dashed line requires a 1½" tube/SL10 clutch
- **Section 3:** Shades in the blue section requires a 2" tube/SL20 clutch.
- **Section 4:** Shades in the orange section requires a 2½" tube/Galaxy 200 clutch







## COLOR LUX® SHANGRI-LA® SHEER HORIZONTAL SHADINGS



COLORLUX® SHANGRI-LA SHEER SHADINGS

- Color Lux Printed Sheer Shadings are a window shading of unique beauty and performance for the finishing touch to a beautiful window and room.
- Horizontal fabric vanes float between two layers of soft, knitted fabric sheers to soften your view outside.
- Color Lux Printed Sheer Shadings is available to widths of 120" and drops to 132" to provide visual elegance to the widest of windows.
- Color Lux Printed Sheer Shadings are available in 3-inch vane widths in both light filtering and room darkening fabrics.
- The sophisticated 25 patterns of white on white Color Lux Printed Sheer Shadings is designed to flatter your decor.
- A printed white fabric insert head rail is standard. Smooth and metallic options are available.
- Vanes glide from open to closed to out of sight with elegant hardware.
- Choose from multiple hardware options to customize your shading: traditional cord loop, retractable cord, cordless, cordless PowerTouch with Touch and Go feature or Simplicity Integrated Rechargeable Motorization.
- Only the Omni-View cord system provides five distinctly different variations of vane position for numerous combinations of privacy, view and light control.
- Only with Color Lux Printed Sheer Shadings, can you partially raise the shading with the fabric vanes in the open, view-through position so you keep your view and still feel the outdoor breeze.
- Create your customers own sophisticated look with the low light gap Designer Cassette Head Rail.
- Easy to install hardware and brackets allow for effortless installations and easy removal for cleaning.
- Color Lux Printed Sheer Shadings may be ultrasonically or traditionally cleaned to stay bright and beautiful.
- A Limited Lifetime Warranty serves as a commitment to your satisfaction.

### HARDWARE OPTIONS



	Key Features	Color Options	Hardware Size (Depth x Height)	Shade Size Available	More Information
<b>Cord Loop</b> 	<ul style="list-style-type: none"> <li>• Cord Loop makes operation easy</li> <li>• Smooth &amp; quiet operation</li> <li>• Braided cord loop is used to raise and lower the shading</li> <li>• Bead Cord is optional</li> </ul>	<ul style="list-style-type: none"> <li>• White</li> <li>• Ivory</li> <li>• Onyx Black</li> <li>• Oil Rubbed Bronze</li> <li>• Brushed Nickel</li> </ul>	Smooth Face: 3¾" x 2¾"  Fabric Insert: 3¾" x 2⅞"	Width: 12" to 120"*  Length: 12" to 132"***	Page 115
<b>Retractable Cord</b> 	<ul style="list-style-type: none"> <li>• Single Cord Design</li> <li>• Provides easy one hand operation</li> <li>• Maintains a consistent length</li> <li>• Enhances child and pet safety</li> </ul>	<ul style="list-style-type: none"> <li>• White</li> <li>• Black</li> <li>• Bronze</li> </ul>	Smooth Face: 3¾" to 2¾"  Fabric Insert: 3¾" to 2⅞"	Width: 12" to 120"*  Length: 12" to 132"***	Page 117
<b>Cordless Shading</b> 	<ul style="list-style-type: none"> <li>• Cord Free</li> <li>• Roller catch mechanism in the head rail</li> <li>• Vanes easily adjusted into various positions</li> </ul>	<ul style="list-style-type: none"> <li>• Clear handle</li> <li>• Bottom Rail is coordinated to the fabric (not matched to head rail)</li> </ul>	Smooth Face: 3¾" to 2¾"  Fabric Insert: 3¾" to 2⅞"	Width: 20" to 84"  Length: 18" to 96"	Page 119
<b>Simplicity Rechargeable Motorization</b> 	<ul style="list-style-type: none"> <li>• Features a battery powered motor utilizing a rechargeable integrated battery pack</li> <li>• Raise &amp; lower shading with click of a button</li> <li>• Great for large and hard to reach windows</li> <li>• Remote can operate multiple shades</li> </ul>	<ul style="list-style-type: none"> <li>• Designer Cassette options</li> <li>• 5 Channel Black or White Remote</li> <li>• 6 Channel white Remote with timer</li> </ul>	Smooth Face: 3¾" to 2¾"  Fabric Insert: 3¾" to 2⅞"	Width: 18" to 120"*  Length: 12" to 132"***	Page 129
<b>PowerTouch Rechargeable</b> 	<ul style="list-style-type: none"> <li>• Raise &amp; lower shading with push of a button</li> <li>• Eliminate the need to stand by the shading to operate; just touch and go</li> <li>• Favorite position button</li> <li>• Rechargeable battery with recharge port on pendant</li> </ul>	<ul style="list-style-type: none"> <li>• Wand and pendant available in white or black</li> </ul>	Smooth Face: 3¾" x 2¾"  Fabric Insert: 3¾" x 2⅞"	Width: 18" to 120"  Length: 12" to 132"	Page 125

\* Maximum width of 120" IB, 119¾" OB

\*\* Light Filtering 132", Room Darkening 122"

# Color Lux® Shangri-La Sheer Horizontal Shadings

## HARDWARE OPTIONS

	Key Features	Color Options	Hardware Size (Depth x Height)	Shade Size Available	More Information
<b>Two on One Head Rail</b> 	<ul style="list-style-type: none"> <li>Operate two shades on one rail</li> <li>Great for larger windows</li> <li>Individually operating shades</li> <li>Available with Cord Loop, PowerTouch Rechargeable, Simplicity and Retractable Cord</li> <li>Not available with cordless</li> </ul>	<ul style="list-style-type: none"> <li>White</li> <li>Ivory</li> <li>Onyx Black</li> <li>Oil Rubbed Bronze</li> <li>Brushed Nickel</li> </ul>	Smooth Face: 3 3/4" x 2 3/4"  Fabric Insert: 3 3/4" x 2 7/8"	Individual Side Width: 12" to 102"  Width: 24 3/8" to 140"  Length: See Designer Cassette Specs	Page 118
<b>DoorStyles</b> 	<ul style="list-style-type: none"> <li>Great option for narrow windows and doors</li> <li>Does not raise/lower, articulate vanes only</li> <li>No Pull cords</li> <li>Secure to door with hold down brackets</li> </ul>	<ul style="list-style-type: none"> <li>Rails and end caps are coordinated to the fabric color</li> </ul>	2" x 1/2"	Width: 6" to 72"  Length: 12" to 72"+	Page 121
<b>Highlights Cornice Valance</b> 	<ul style="list-style-type: none"> <li>Adds height to windows and hides hardware</li> <li>Available as inside and outside mount</li> <li>Easy to install</li> </ul>	<ul style="list-style-type: none"> <li>All Color Lux Roller Fabrics</li> <li>All Envision Roller Fabrics</li> </ul>	Width: 24" to 216"  Height: 6"  Returns: 1 1/2" to 6"	Varies by selected fabric  Width: 12" to 94"	Page 55

+ Maximum length varies by width

# Color Lux® Shangri-La Sheer Horizontal Shadings

## FABRIC COLLECTIONS

Color Lux Printed Sheer Shadings are available with different fabric collections.

COLLECTION	3" Vanes
Light Filtering	•
Room Darkening	•
Linen Light Filtering	NA

**Please Note:** Room Darkening fabrics are not blackout fabrics. Knitted fabric may experience minor weave variations due to heat, humidity and other room conditions. These variations can result in light bowing, puckering and dimpling of the Shangri-La material. This is considered normal and does not constitute a failure in either workmanship or materials. The possible variations are minor and have been shown through case study not to detract from the beauty of the product.

# Color Lux® Shangri-La Sheer Horizontal Shadings

## HARDWARE OPTION AVAILABILITY

Use this table to ensure your coordinating options and unique shapes are consistent with your product selections.

CORD LOOP	3" Vanes
Cord Loop	•
Cord Loop Two-On-One	•
RETRACTABLE CORD	
Retractable Cord	•
Retractable Cord Two-On-One	•
CORDLESS SHADING	
Cordless Shading	•
Cordless Shading Two-On-One	NA
SIMPLICITY MOTORIZATION	
Simplicity Motorization	•
Simplicity Motorization Two-On-One	•
SIMPLICITY RECHARGEABLE MOTORIZATION	
Simplicity Rechargeable	•
Simplicity Rechargeable Two-On-One	•
POWERTOUCH RECHARGEABLE MOTORIZATION	
PowerTouch Rechargeable	•
PowerTouch Rechargeable Two-On-One	•
DOORSTYLE	
DoorStyle	•



Smooth Face Designer Cassette



Fabric Insert Designer Cassette

# Color Lux® Shangri-La Sheer Horizontal Shadings

## SIZE STANDARDS



		Cord Loop	Retractable Cord	Cordless Shading
<b>ALL FABRICS</b>	Minimum Width	12"	12"	20"
	Minimum Length	12"	12"	12"

Light Filtering	Price Group	Page		Cord Loop	Retractable Cord	Cordless Shading
<b>3" Vanes</b>	27	113	Maximum Width & Length	120"* x 132"	120"* x 132"	84" x 96"

Room Darkening	Price Group	Page		Cord Loop	Retractable Cord	Cordless Shading
<b>3" Vanes</b>	28	113	Maximum Width & Length	120"* x 122"	120"* x 122"	84" x 96"

				Cord Loop	Retractable Cord	Cordless Shading
More Information On Page				Page 115	Page 117	Page 119

\* Maximum width of 120" IB, 119¾" OB

SIZE STANDARDS



		Motorization	Motorization	Two-On-One
		Simplicity Rechargeable	PowerTouch Rechargeable	
ALL FABRICS	Minimum Width	18"	18"	See Table Below <sup>+</sup>
	Minimum Length	12"	12"	12"

				Motorization	Motorization	Two-On-One
				Simplicity Rechargeable	PowerTouch Rechargeable	
Light Filtering	Price Group	Page				
3" Vanes	27	113	Maximum Width & Length	120"* x 132"	120"* x 132"	140" x 132"

				Motorization	Motorization	Two-On-One
				Simplicity Rechargeable	PowerTouch Rechargeable	
Room Darkening	Price Group	Page #				
3" Vanes	28	113	Maximum Width & Length	120"* x 122"	120"* x 122"	140" x 122"

				Motorization	Motorization	Two-On-One
				Simplicity Rechargeable	PowerTouch Rechargeable	
More Information On Page				Page 125	Page 123	Page 118

\* Maximum width of 120" IB, 119¾" OB

	Minimum Width	Hardware
TWO-ON-ONE HARDWARE+	24"	Cord Loop
	24"	Retractable Cord
	NA	Cordless
	28"	Simplicity Motorization
	36"	Simplicity Rechargeable
	36"	PowerTouch Rechargeable



# Color Lux® Shangri-La Sheer Horizontal Shadings

## SIZE STANDARDS



		DoorStyles
ALL FABRICS	Minimum Width	6"
	Minimum Length	12"

Light Filtering	Price Group	Page	DoorStyles
3" Vanes	29	114	Maximum Width & Length 72" x 96"*

Room Darkening	Price Group	Page	DoorStyles
3" Vanes	30	114	Maximum Width & Length 72" x 96"*

		DoorStyles
More Information On Page		Page 125

\* Maximum length varies by width. Maximum length for doorstyles over 36" wide is 72".



COLORLUX® SHANGRI-LA SHEER SHADINGS

# Color Lux® Shangri-La Sheer Horizontal Shadings

## HARDWARE UPGRADE OPTIONS

LIFT SYSTEM	UPGRADES	ADD
Cord Loop	Bottom Up	Included
Retractable Cord	Bottom Up	\$102
Cordless Shading	Bottom Up	\$102

DESIGNER UPGRADE OPTIONS	UPGRADES	ADD
Add to Any Lift System Upgrade (Chart to the left)	Metallic Hardware	\$138
	Scotchgard Stain Protection	\$54
	Highlights Valance <i>See Page 55 For More Information</i>	

ADDITIONAL OPTIONS	UPGRADES	ADD
Add to Any Upgrade Above	Two-On-One Head Rail	Price as two shadings and add together.
Accessories	6 Foot Expandable Pole	\$62
	12 Foot Expandable Pole	\$75

## Shangri-La Sheer Horizontal Shadings **Motorized** Hardware Upgrade Options

MOTORIZED	UPGRADES	ADD	
PowerTouch Rechargeable Motorization System	Rechargeable Integrated Battery Pack	\$179	For More Information Page 123
	Plug-In Charger for Rechargeable Li-Ion	\$42	
Simplicity Integrated Rechargeable Motorization System	Motor and Integrated Battery Pack	\$485	For More Information Page 125
	Simplicity 5 Channel Remote	\$62	
	Simplicity 6 Channel Remote with Timer	\$102	
	Simplicity 14 Channel White Remote	\$102	
	Plug-In Charger for Rechargeable Li-Ion	\$42	
	7.4v Solar Panel	\$160	
Simplicity Smart Controller System	NEO Controller	\$510	For More Information Page 128
	NEO Application for Mobile Devices	FREE	

### Color Lux Shangri-La Sheer Horizontal Sheer Shading Pricing Examples

#### Two-On-One Pricing Example:

3" Light Filtering 42" x 60" Shadings:	\$1315.00 x 2 \$2630.00
Retractable Cord Upgrade:	\$102.00 x 2 \$204.00
<b>Total List Price:</b>	<b>\$2834.00</b>

#### Simplicity Rechargeable Motorization Pricing Example:

3" Light Filtering 42" x 60" Shade:	\$1315.00
Metallic Hardware Option	\$138
Simplicity Rechargeable Surcharge:	\$485.00
Charger for Rechargeable (required):	\$42.00
Simplicity Remote Control:	\$62.00
<b>Total List Price:</b>	<b>\$2042.00</b>

# Color Lux® Shangri-La Sheer Horizontal Shadings

## PRICING

### 3" Light Filtering Vanes

### PRICE GROUP 27 Cord Loop

		Width In Inches												
		24	30	36	42	48	54	60	66	72	84	96	108	120
Length In Inches	36	758	850	952	1040	1139	1239	1330	1429	1670	1876	2070	2513	2958
	42	799	901	1001	1113	1216	1328	1429	1531	1784	2006	2212	2697	3183
	48	846	954	1071	1178	1292	1406	1528	1647	1903	2133	2361	2892	3416
	54	881	1000	1124	1248	1375	1495	1630	1767	2019	2259	2527	3164	3798
	60	922	1057	1184	1315	1445	1593	1731	1877	2125	2403	2693	3380	4068
	66	963	1106	1245	1386	1531	1685	1847	1997	2241	2555	2863	3594	4323
	72	1001	1155	1306	1456	1617	1784	1949	2114	2361	2697	3033	3830	4622
	78	1032	1196	1353	1520	1691	1865	2035	2213	2474	2835	3183	4022	4859
	84	1075	1245	1409	1599	1776	1960	2151	2337	2602	2988	3355	4224	5098
	90	1121	1292	1475	1668	1862	2067	2252	2451	2727	3130	3522	4458	5392
	96	1161	1346	1535	1744	1949	2152	2355	2560	2855	3276	3690	4682	5671
	102	1331	1539	1753	1983	2191	2390	2672	2933	3135	3567	3977	4811	5794
	108	1401	1620	1847	2087	2300	2521	2809	3088	3304	3747	4189	5065	5941
	114	1485	1719	1958	2212	2451	2680	2980	3275	3505	3977	4439	5374	6309
120	1599	1842	2102	2369	2614	2863	3184	3505	3748	4260	4753	5752	6744	
126	1700	1960	2240	2522	2790	3051	3395	3741	3998	4543	5067	6130	7197	
132	1813	2089	2386	2687	2970	3258	3618	3985	4261	4840	5400	6535	7669	

### 3" Room Darkening Vanes

### PRICE GROUP 28 Cord Loop

		Width In Inches												
		24	30	36	42	48	54	60	66	72	84	96	108	120
Length In Inches	36	834	935	1047	1144	1253	1363	1463	1571	1837	2064	2277	2765	3254
	42	878	991	1101	1224	1338	1460	1571	1684	1962	2206	2433	2967	3501
	48	931	1049	1178	1295	1421	1546	1681	1812	2092	2345	2597	3180	3758
	54	970	1100	1237	1374	1513	1645	1793	1944	2221	2484	2780	3480	4177
	60	1014	1163	1302	1446	1590	1753	1905	2065	2337	2643	2962	3718	4475
	66	1060	1216	1369	1525	1684	1854	2033	2197	2465	2810	3149	3954	4756
	72	1101	1270	1437	1602	1780	1962	2143	2326	2597	2967	3337	4213	5085
	78	1136	1316	1489	1671	1860	2051	2238	2434	2721	3119	3501	4425	5346
	84	1182	1369	1551	1759	1953	2156	2366	2571	2862	3287	3691	4646	5608
	90	1232	1421	1622	1835	2049	2274	2478	2696	3000	3442	3874	4904	5931
	96	1277	1481	1688	1919	2143	2367	2590	2817	3140	3603	4059	5150	6238
	102	1464	1693	1928	2181	2411	2629	2939	3226	3449	3923	4375	5292	6374
	108	1541	1782	2033	2295	2530	2773	3089	3398	3634	4122	4607	5571	6536
	114	1633	1890	2153	2433	2696	2948	3278	3602	3855	4375	4883	5911	6941
120	1759	2026	2312	2606	2875	3149	3502	3855	4123	4686	5228	6327	7418	
122	1870	2156	2464	2774	3070	3356	3735	4115	4398	4997	5575	6743	7917	

LIFT SYSTEM	UPGRADES	ADD	DESIGNER UPGRADE OPTIONS	UPGRADES	ADD
Cord Loop	Bottom Up	Included	Add to Any Lift System Upgrade (Chart to the left)	Metallic Hardware	\$138
Retractable Cord	Bottom Up	\$102		Scotchgard Stain Protection	\$54
Cordless Shading	Bottom Up	\$102		Highlights Valance <i>See Page 55 For More Information</i>	
ADDITIONAL OPTIONS	UPGRADES	ADD			
Add to Any Upgrade Above	Two-On-One Head Rail	Price as two shadings and add together.			
Accessories	6 Foot Expandable Pole	\$62			
	12 Foot Expandable Pole	\$75			
MOTORIZATION					MORE INFO
For motorization surcharges and options refer to page 112.					Pg 112

Shadings wider than 96": Shadings over 96" in width may require additional fabrication and delivery time.

PRICING

3" Light Filtering Vanes

PRICE GROUP 29  
DoorStyles\*

		Width In Inches											
		6	12	18	24	30	36	42	48	54	60	66	72
Length In Inches	12	646	660	680	693	773	871	935	953	1058	1079	1102	1306
	18	647	668	685	706	794	894	966	987	1097	1126	1150	1377
	24	650	677	696	721	808	919	991	1020	1142	1168	1201	1439
	30	656	682	708	733	826	938	1024	1053	1185	1218	1249	1501
	36	659	685	720	762	854	957	1045	1145	1243	1336	1434	1680
	42	706	742	774	802	905	1006	1117	1222	1333	1434	1539	1793
	48	728	768	874	850	959	1075	1185	1298	1415	1534	1655	1911
	54	745	791	836	884	1004	1128	1254	1380	1504	1636	1774	2029
	60	769	818	865	925	1061	1189	1320	1452	1601	1738	1886	2134
	66	813	865	922	966	1112	1250	1392	1539	1693	1856	2006	2251
	72	836	896	957	1006	1160	1312	1463	1624	1793	1957	2124	2374
	78	854	923	987	1036	1201	1358						
84	884	953	1024	1079	1250	1417							
90	907	984	1060	1125	1298	1480							
96	935	1014	1096	1165	1352	1543							

3" Room Darkening Vanes

PRICE GROUP 30  
DoorStyles\*

		Width In Inches											
		6	12	18	24	30	36	42	48	54	60	66	72
Length In Inches	12	711	726	748	762	850	958	1029	1048	1164	1187	1212	1437
	18	712	735	754	777	873	983	1063	1086	1207	1239	1265	1515
	24	715	745	766	793	889	1011	1090	1122	1256	1285	1321	1583
	30	722	750	779	806	909	1032	1126	1158	1304	1340	1374	1651
	36	725	754	792	838	939	1053	1150	1260	1367	1470	1577	1848
	42	777	816	851	882	996	1107	1229	1344	1466	1577	1693	1972
	48	801	845	961	935	1055	1183	1304	1428	1557	1687	1821	2102
	54	820	870	920	972	1104	1241	1379	1518	1654	1800	1951	2232
	60	846	900	952	1018	1167	1308	1452	1597	1761	1912	2075	2347
	66	894	952	1014	1063	1223	1375	1531	1693	1862	2042	2207	2476
	72	920	986	1053	1107	1276	1443	1609	1786	1972	2153	2336	2611
	78	939	1015	1086	1140	1321	1494						
84	972	1048	1126	1187	1375	1559							
90	998	1082	1166	1238	1428	1628							
96	1029	1115	1206	1282	1487	1697							

ADDITIONAL OPTIONS

Scotchgard Stain Protection	\$54
Six Foot Operator Pole	\$62
Twelve Foot Operator Pole	\$75

\*Rails and endcaps on Shangri-La DoorStyles Shadings are coordinated to the fabric color. Hardware used on DoorStyles may not match standard shadings.

# Color Lux® Shangri-La Sheer Horizontal Shadings

## CORD LOOP SHADING HARDWARE SYSTEM | DESIGNER CASSETTE HEAD RAIL

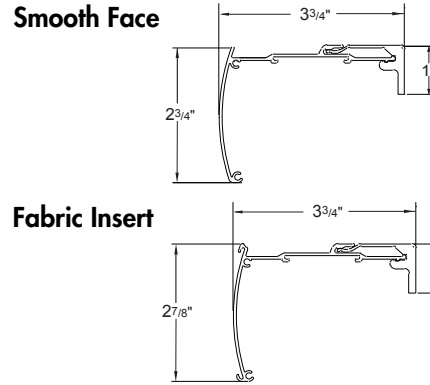

- Smooth Face Designer Cassette Head Rail**
- Depth of rail and bracket: 3 3/4"
  - Height of rail: 2 3/4"
  - Height of bracket: 1"

- Fabric Insert Designer Cassette Head Rail**
- Depth of rail and bracket: 3 3/4"
  - Height of rail: 2 7/8"
  - Height of bracket: 1"

Hardware Features	
Standard Designer Cassette	Choose from a printed vane insert or painted Smooth Face rail. Default head rail color is White or Ivory based on shading vane color.
Bottom Rail Color	Color coordinated rail with White/Ivory head rail. Bottom rail will be matched to Oil Rubbed Bronze or Onyx Black when metallic upgrade is selected.
Upgrades	
Designer Metallic Upgrade (Fabric Insert/Smooth Face)	<ul style="list-style-type: none"> <li>• Oil Rubbed Bronze</li> <li>• Onyx Black</li> <li>• Brushed Nickel</li> </ul>
Mounting Dimensions	
Designer Cassette Head Rail	
Minimum Shallow Mount	1"
Minimum Flush Inside Mount (including brackets)	3 3/4"
Minimum Outside Mount	1"
Minimum Side Mount	1 1/4"
Width Side Mount	48" Max width side mount
Finished Dimensions	
Inside Mount	
	<ul style="list-style-type: none"> <li>• Fabric will measure ordered width less: 1"</li> <li>• Head rail* will measure ordered width less: 3/16"</li> </ul>
Side (End) Mount	
	<ul style="list-style-type: none"> <li>• Fabric will measure ordered width less: 1 1/2"</li> <li>• Head rail* will measure ordered width less: 1 1/16"</li> </ul>
Outside Mount	
	<ul style="list-style-type: none"> <li>• Fabric will measure ordered width less: 5/8"</li> <li>• Head rail* will measure ordered width plus: 3/16"</li> </ul>
Exact (End Cap to End Cap) Mount	
	<ul style="list-style-type: none"> <li>• Fabric will measure ordered width less: 1 3/16"</li> <li>• Head rail* will measure ordered width</li> </ul>
* Head rail measurements include endcaps. Width and length measurements may vary +/- 1/8"	

Please Note: Once ordered and manufactured, the width of the Shangri-La fabric cannot be altered. Comfortex makes deductions to the width depending on the type of mounting indicated. For all mounting types, fabric will measure exactly the length ordered when the vanes are in the closed position.

# Color Lux® Shangri-La Sheer Horizontal Shadings

## CORD LOOP SHADING HARDWARE SYSTEM | DESIGNER CASSETTE HEAD RAIL

### Head Rail Inserts

Fabric head rail inserts are used on Designer Cassette Head Rail Shadings when specified.

We use a printed vane insert strip on all shadings including room darkening colors. The insert strip is a printed vane from the same fabric used on the shading.

### Cord Type and Color

White, black or bronze loop cord coordinates with your hardware choice. Bead cord is optional in white, bronze, black or steel. Cord tensioners match your hardware choice (white, black or bronze).

### Reverse Roll

The braided cord does not have a reverse roll stop. If a shading with the Designer Cassette hardware is raised above 24" in the reverse roll mode, there is a possibility of the fabric rubbing on the head rail. Comfortex reserves the right NOT to warrant wear and tear of fabric if damaged by roll-up in excess of 24".

### Length Considerations with Shangri-La Shadings

Comfortex will fabricate your Shangri-La Window Shading to the length ordered, when the vanes are in the closed position (Figure A).

- When the vanes are rotated to the open position, the shading will become slightly longer.
- When opened on an inside mount, the shading will be slightly longer than ordered length.
- A slight puckering may occur when the vanes are in the open position. Rotating the vanes closed will cause the bottom rail to touch the window sill, before it begins to raise.

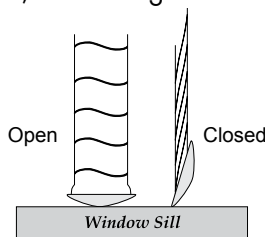

Figure A

### Side By Side Alignment

When Shangri-La Window Shadings are installed side-by-side, vane alignment can be guaranteed within 1/4" only if:

- The shadings are the same color and ordered at the same time.
- The sum total of the widths of all shadings needing alignment is less than 118".

Side-by-side lineup is specified when the order is placed.

### Omni-View System

Shangri-La Shadings feature the Omni-View™ Cord System. The Omni-View System provides the ability to manipulate the shading into various viewing positions. There are variations in visibility through the shadings when the vanes are tilted to their maximum open positions. The following five modes can be obtained with standard shading operation when viewing the shading at eye level.

- **Closed top, open bottom:** By partially lowering the shading from the fully raised position, the upper portion of your window will become semi-opaque while allowing a clear view below.
- **Fully private:** When lowered completely, Shangri-La provides complete privacy and softly diffused light.
- **Partially open:** Opening Shangri-La slightly will gradually increase the level of light and allow varying levels of view through.
- **View-through when lowered:** By completely opening the vanes, Shangri-La provides a softened, veiled view to the outside.
- **View-through when raised:** From the open or view-through position, continuing to pull down on the back of the cord will raise the fabric allowing a clear view outside from below, and a veiled view above. This exclusive feature allows Shangri-La to be raised up to 24" in this mode.
- Comfortex recommends that you **do not** raise the shading more than 24" off the sill in the view-through when raised mode. Refer to warranty section below for more information.
- Omni-View is only available with Shangri-La Shadings built with braided cord loop.

### Cord Information For Shangri-La Shadings

A braided cord loop is used to raise and lower the shading. White, black or bronze loop cord matches your hardware choice. Cord tensioner will match the hardware color.

Bead cord is available in black, white, bronze, nickel and steel.

The cord loop will measure the length indicated below unless otherwise specified.

Shade Length	Standard Loop
16" to 26 <sup>7</sup> / <sub>8</sub> "	1' (12")
27" to 39 <sup>7</sup> / <sub>8</sub> "	2' (24")
40" to 59 <sup>7</sup> / <sub>8</sub> "	3' (36")
60" to 83 <sup>7</sup> / <sub>8</sub> "	4' (48")
84" to 107 <sup>7</sup> / <sub>8</sub> "	5' (60")
108" and greater	6' (72")

Maximum cord length is 15 feet. Polyester cord can be ordered in custom lengths in 1 foot increments only.

### Braided Cord Loop Warranty Information

The shadings built with a braided cord loop do not have a reverse roll stop. If a shading is raised above 24" in the reverse roll mode, there is a possibility of the fabric rubbing on the head rail. Comfortex reserves the right NOT to warrant wear and tear of fabric if damaged by roll-up in excess of 24".



# Color Lux® Shangri-La Sheer Horizontal Shadings

## RETRACTABLE CORD HARDWARE SYSTEM | DESIGNER CASSETTE HEAD RAIL



**Smooth Face**

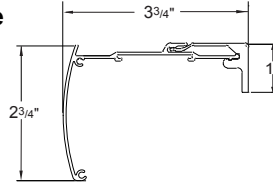

**Smooth Face Designer Cassette Head Rail**

- Depth of rail and bracket: 3 3/4"
- Height of rail: 2 3/4"
- Height of bracket: 1"

**Fabric Insert**

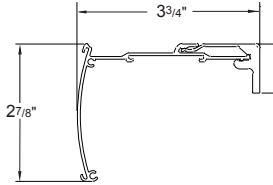

**Fabric Insert Designer Cassette Head Rail**

- Depth of rail and bracket: 3 3/4"
- Height of rail: 2 7/8"
- Height of bracket: 1"

Hardware Features	
Standard Designer Cassette	Choose from a printed vane insert or painted Smooth Face rail. Default head rail color is White or Ivory based on shading vane color.
Bottom Rail Color	Color coordinated rail with White/Ivory head rail. Bottom rail will be matched to Oil Rubbed Bronze or Onyx Black when metallic upgrade is selected.
Upgrades	
Designer Metallic Upgrade (Fabric Insert/Smooth Face)	<ul style="list-style-type: none"> <li>• Oil Rubbed Bronze</li> <li>• Onyx Black</li> </ul>
Mounting Dimensions	
Finished Dimensions	
Mounting and Finished Dimensions are the same as Cord Loop See Page 115	

### Retractable Cord Shadings

The Retractable Cord option is a single cord design that provides easy one hand operation to raise, lower and open and close the vanes.

- Retractable Cord hardware is an alternative to conventional cord loop controls. The short retractable cord maintains a consistent length whether the shadings are raised or lowered. The elimination of cord loop enhances child and pet safety.
- Available with all fabrics with Designer Cassette.
- White, black or bronze cord and tassel coordinates your hardware color choice.
- Standard cord length is 40% the length of the shading. Cord may be shortened to match consumer operating preferences and to keep out of reach of children. Cord length can be easily modified in the field.
- Mounting a cord tensioner is not necessary. Cord cleat is recommended.

### Overall Operation

When raising and lowering the shading, pull the cord down in long, even strokes. Allow the cord to fully retract into the head rail after each downward stroke.

### To Lower The Shading And Open The Vanes

- Pull the cord down toward the center of the shading with long strokes. Continue until the shading is fully lowered and the vanes are open.
- Allow the cord to retract completely into the head rail after each downward stroke.
- The shading can be stopped at any point while lowering

### To Tilt The Vanes And Raise Shading

- Pull the cord straight down or down and slightly out with long strokes. With each stroke the shading partially raises.
- Allow the cord to retract completely into the head rail after each downward stroke.
- Use multiple strokes until the shading reaches the desired position.
- The shading can be stopped at any point while raising.

# Color Lux® Shangri-La Sheer Horizontal Shadings

## TWO-ON-ONE HARDWARE SYSTEM | DESIGNER CASSETTE HEAD RAIL

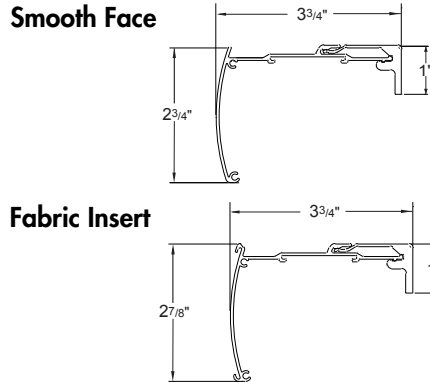

- Smooth Face Designer Cassette Head Rail**
- Depth of rail and bracket: 3 3/4"
  - Height of rail: 2 3/4"
  - Height of bracket: 1"

- Fabric Insert Designer Cassette Head Rail**
- Depth of rail and bracket: 3 3/4"
  - Height of rail: 2 7/8"
  - Height of bracket: 1"

Hardware Features	
Standard Designer Cassette	Choose from a printed vane insert or painted Smooth Face rail. Default head rail color is White or Ivory based on shading vane color.
Bottom Rail Color	Color coordinated rail with White/Ivory head rail. Bottom rail will be matched to Oil Rubbed Bronze or Onyx Black when metallic upgrade is selected. With Brushed Nickel Headrail, bottom rail will be coordinated to fabric.
Upgrades	
Designer Metallic Upgrade (Fabric Insert/Smooth Face)	<ul style="list-style-type: none"> <li>• Oil Rubbed Bronze</li> <li>• Onyx Black</li> <li>• Brushed Nickel</li> </ul>
Mounting Dimensions	
Finished Dimensions	
Mounting and Finished Dimensions are the same as Cord Loop See Page 115	

### Two-On-One Designer Cassette Head Rail

Two-On-One Head Rail shadings are two shadings sharing the same head rail; each shading operates independently.

- Two-On-One Head Rail can be combined with cord loop, PowerTouch Rechargeable, Simplicity Motorization and retractable cord hardware options. Price as two shadings (including upgrades) and add together. Pricing example on page 112.
- Two-On-One not available with cordless.
- Specify shading total width and two individual section widths. **Note:** The two individual sections must add up to the total width.
- Two on One Head Rail Shadings are available with all vane sizes.
- Two on One Head Rail Shadings are available with bead cord or braided cord loop. See page 116 for more information.
- Controls will always be placed to the far left and far right.
- Available in widths up to 140" with Designer Cassette hardware.
- Minimum single section width is 12". Maximum single section width is 102". The center gap between shadings is 3/8".
- Side by side alignment is available if the two panels measure less than 120". Alignment must be specified when the order is placed.
- Shadings over 98" are subject to common carrier surcharge. See page 135 for more information on the freight policy.

# Color Lux® Shangri-La Sheer Horizontal Shadings

## CORDLESS HARDWARE SYSTEM | DESIGNER CASSETTE HEAD RAIL



**Smooth Face**

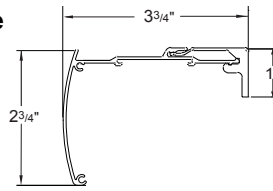

**Fabric Insert**

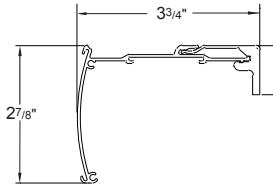

### **Smooth Face Designer Cassette Head Rail**

- Depth of rail and bracket: 3 3/4"
- Height of rail: 2 3/4"
- Height of bracket: 1"

### **Fabric Insert Designer Cassette Head Rail**

- Depth of rail and bracket: 3 3/4"
- Height of rail: 2 7/8"
- Height of bracket: 1"

<b>Hardware Features</b>	
Standard Designer Cassette	Choose from a printed vane insert or painted Smooth Face rail. Default head rail color is White or Ivory based on shading vane color.
Bottom Rail Color	Color coordinated rail with White/Ivory head rail. Bottom rail will be matched to Oil Rubbed Bronze or Onyx Black when metallic upgrade is selected. Hinged handle is clear. With Brushed Nickel Headrail, bottom rail will be coordinated to fabric.
<b>Upgrades</b>	
Designer Metallic Upgrade (Fabric Insert/Smooth Face)	<ul style="list-style-type: none"> <li>• Oil Rubbed Bronze</li> <li>• Onyx Black</li> <li>• Brushed Nickel</li> </ul>
<b>Mounting Dimensions</b>	
<b>Designer Cassette Head Rail</b>	
Minimum Shallow Mount	1"
Minimum Flush Inside Mount (including brackets)	3 3/4"
Minimum Outside Mount	1"
Minimum Side Mount	1 1/4"
Maximum Side Mount	48"
<b>Finished Dimensions</b>	
<b>Inside Mount</b>	
	<ul style="list-style-type: none"> <li>• Fabric will measure ordered width less: 7/8"</li> <li>• Head rail* will measure ordered width less: 3/16"</li> </ul>
<b>Side (End) Mount</b>	
	<ul style="list-style-type: none"> <li>• Fabric will measure ordered width less: 1 3/8"</li> <li>• Head rail* will measure ordered width less: 1 1/16"</li> </ul>
<b>Outside Mount</b>	
	<ul style="list-style-type: none"> <li>• Fabric will measure ordered width less: 1/2"</li> <li>• Head rail* will measure ordered width plus: 3/16"</li> </ul>
<b>Exact (End Cap to End Cap) Mount</b>	
	<ul style="list-style-type: none"> <li>• Fabric will measure ordered width less: 1 1/16"</li> <li>• Head rail* will measure ordered width</li> </ul>
* Head rail measurements include endcaps. Width and length measurements may vary +/- 1/8"	

Please Note: Once ordered and manufactured, the width of the Shangri-La fabric cannot be altered. Comfortex makes deductions to the width depending on the type of mounting indicated. For all mounting types, fabric will measure exactly the length ordered when the vanes are in the closed position.

# Color Lux® Shangri-La Sheer Horizontal Shadings

## CORDLESS HARDWARE SYSTEM | DESIGNER CASSETTE HEAD RAIL

### Cordless Shangri-La Shadings Head Rail

- The Standard Designer Cassette head rail is white or ivory aluminum with a coordinating fabric insert or Smooth Face.
- Designer Cassette head rail is also available in Oil Rubbed Bronze, Brushed Nickel and Onyx Black.
- Shangri-La Cordless Sheer Horizontal Shadings use quick-snap, no-light-gap brackets.

### Cordless Shangri-La Shadings Bottom Rail

- Bottom rail includes a sliding weight to adjust fabric skewing if necessary.

**Please note:** On Cordless Shangri-La Shadings the bottom rail is color coordinated to the fabric (not matched to the head rail). Hinged handle is clear.

### Operating A Cordless Shangri-La Shading

Cordless Shangri-La Shadings utilize a roller catch mechanism in the head rail which allows for the vanes to be adjusted into various positions.

Pull the handle that is attached to the bottom rail until the shading reaches the desired length, allow catch mechanism to engage and lock shade in desired position.

### To Open Or Close Vanes

Lower the shading all the way down and continue pulling down on the handle until the vanes open. The roller catch mechanism allows the vanes to be adjusted open, closed and to various positions in between.

When adjusting the vane position, release the catch by tugging on the handle, roll up the shading several inches (this resets the catch mechanism), then pull back down to the desired position.

- The Omni-View setting is not available with Shangri-La Cordless Shadings.

### To Raise The Shading

Pull down on the handle to release the catch mechanism and let the shading rise. Tug the handle to lock the shade in the desired position.

When first learning to operate the shading, it may take a few tries to get the feel of the mechanism.



*Cordless Handle*



*Cordless Handle Being Pulled Down*



*Cordless Handle on Window Sill*

# Color Lux® Shangri-La Sheer Horizontal Shadings

## SHANGRI-LA DOORSTYLES HARDWARE SYSTEM



<b>Hardware Features</b>	
Standard Hardware	Hardware used on DoorStyles Shadings may not match standard shadings.
Bottom Rail Color	Rails and end caps on Shangri-la DoorStyles Shadings are coordinated to the fabric color. With Brushed Nickel Headrail, bottom rail will be coordinated to fabric.
<b>Upgrades</b>	
Designer Metallic Upgrade	Not Available
Hinges & Handle	Polished Brass
<b>Mounting Dimensions</b>	
<b>DoorStyles Hardware</b>	
Minimum Shallow Mount	1 1/2"
Minimum Flush Inside Mount (including brackets)	2 5/8"
Minimum Outside Mount	3/4"
<b>Finished Dimensions</b>	
<b>Inside Mount</b>	
	<ul style="list-style-type: none"> <li>Fabric will measure ordered width less: 5/16"</li> <li>Head rail* will measure ordered width less: 3/16"</li> </ul>
<b>Outside Mount</b>	
	<ul style="list-style-type: none"> <li>Fabric will measure ordered width</li> <li>Head rail* will measure ordered width plus: 3/16"</li> </ul>
<b>Exact (End Cap to End Cap) Mount</b>	
	<ul style="list-style-type: none"> <li>Fabric will measure ordered width less: 3/16"</li> <li>Head rail* will measure ordered width</li> </ul>
* Head rail measurements include endcaps. Width and length measurements may vary +/- 1/8" <b>Side Mount is not available for DoorStyles</b>	

Please Note: Once ordered and manufactured, the width of the Shangri-La fabric cannot be altered. Comfortex makes deductions to the width depending on the type of mounting indicated.

# Color Lux® Shangri-La Sheer Horizontal Shadings

## SHANGRI-LA DOORSTYLES HARDWARE SYSTEM

### Shangri-La DoorStyles Shadings

Shangri-La DoorStyles Shadings cover French doors, transoms and sidelights for a look of sheer perfection without a bulky head rail. They attach to the window frame or door with unobtrusive hinges and tilt open and closed with easy to install hardware. An operating handle allows the fabric to be tilted open and closed (Figure A).

Hardware used on DoorStyle Shadings may not match standard shadings.

### Fabric

All 3" light filtering and room darkening fabric collections are available as DoorStyle Window Shadings.

Rails and end caps on Shangri-La DoorStyles Shadings are coordinated to the fabric color.

**Designer Metallic Hardware Upgrade:** Not available with DoorStyles.

### Operating Pole

An operating pole is available for hard to reach windows and doors. Please specify when ordering.

**6 Foot Expandable Pole**

**12 Foot Expandable Pole**

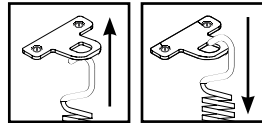

### DoorStyles Shading Specifications

Minimum Width: 6"      Maximum Width: 72"

Minimum Length: 12"      Maximum Length: 72"\*

\*Maximum length varies by width.

DoorStyles are **not** available with 2½" vane fabrics.

**Please Note:** Once ordered and manufactured, the width of the Shangri-La fabric cannot be altered. Comfortex makes deductions to the width depending on the type of mounting indicated. For all mounting types, fabric will measure exactly the length ordered when the vanes are in the open or "view-through" position.

### Length Considerations With Shangri-La DoorStyles

Comfortex will fabricate your Shangri-La DoorStyles to the length ordered when the vanes are in the open (or view through) position. When the vanes are tilted to the closed position, the shading will become 1¾" longer.

When closed on an inside mount or when used with hold down brackets, a slight puckering may occur.

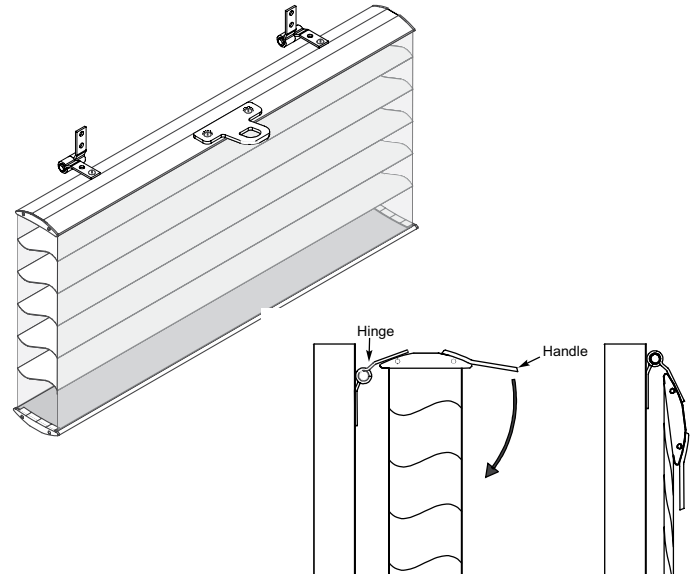
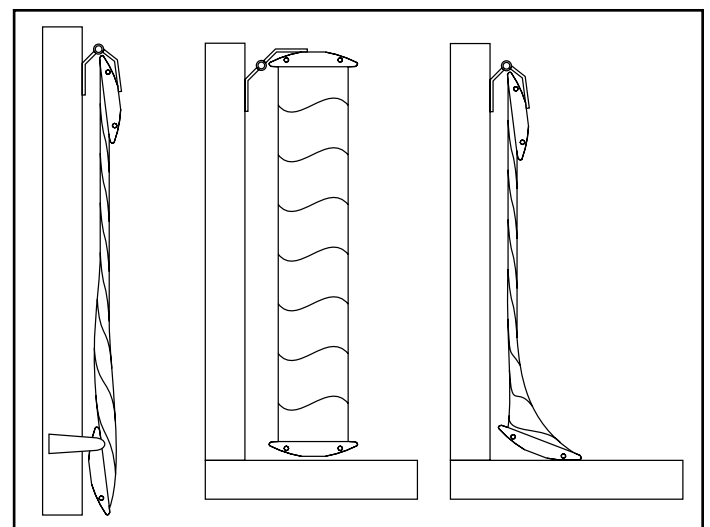

Figure A





# Color Lux® Shangri-La Sheer Horizontal Shadings

## POWERTOUCH RECHARGEABLE HARDWARE SYSTEM | DESIGNER CASSETTE HEAD RAIL

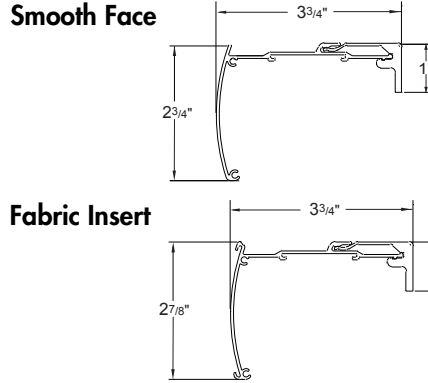

### Smooth Face Designer Cassette Head Rail

- Depth of rail and bracket: 3 3/4"
- Height of rail: 2 3/4"
- Height of bracket: 1"

### Fabric Insert Designer Cassette Head Rail

- Depth of rail and bracket: 3 3/4"
- Height of rail: 2 7/8"
- Height of bracket: 1"

### Hardware Features

Standard Designer Cassette	Choose from a printed vane insert or painted Smooth Face rail. Default head rail color is White or Ivory based on shading vane color.
Bottom Rail Color	Color coordinated rail with White/Ivory head rail. Bottom rail will be matched to Oil Rubbed Bronze or Onyx Black when metallic upgrade is selected. With Brushed Nickel Headrail, bottom rail will be coordinated to fabric.
<b>Upgrades</b>	Available for all Designer Cassette Head Rails
Designer Metallic Upgrade (Fabric Insert/Smooth Face)	<ul style="list-style-type: none"> <li>• Oil Rubbed Bronze</li> <li>• Onyx Black</li> <li>• Brushed Nickel</li> </ul>

Mounting Dimensions	Designer Cassette Head Rail
Minimum Shallow Mount	1"
Minimum Flush Inside Mount (including brackets)	3 3/4"
Minimum Outside Mount	1"
Minimum Side Mount	1 1/4"
Width Side Mount	48" Max width side mount

### Finished Dimensions

Inside Mount	
	<ul style="list-style-type: none"> <li>• Fabric will measure ordered width less: 1"</li> <li>• Head rail* will measure ordered width less: 3/16"</li> </ul>
Side (End) Mount	
	<ul style="list-style-type: none"> <li>• Fabric will measure ordered width less: 1 1/2"</li> <li>• Head rail* will measure ordered width less: 11/16"</li> </ul>
Outside Mount	
	<ul style="list-style-type: none"> <li>• Fabric will measure ordered width less: 5/8"</li> <li>• Head rail* will measure ordered width plus: 3/16"</li> </ul>
Exact (End Cap to End Cap) Mount	
	<ul style="list-style-type: none"> <li>• Fabric will measure ordered width less: 13/16"</li> <li>• Head rail* will measure ordered width</li> </ul>

\* Head rail measurements include endcaps. Width and length measurements may vary +/- 1/8"

Please Note: Once ordered and manufactured, the width of the Shangri-La fabric cannot be altered. Comfortex makes deductions to the width depending on the type of mounting indicated. For all mounting types, fabric will measure exactly the length ordered when the vanes are in the closed position.

# Color Lux® Shangri-La Sheer Horizontal Shadings

## POWERTOUCH RECHARGEABLE HARDWARE SYSTEM | DESIGNER CASSETTE HEAD RAIL

### PowerTouch™ Rechargeable Shades

Sheer Shadings can be fabricated with the PowerTouch Rechargeable Push Button Control option. The PowerTouch Rechargeable option is an easy, cord free motorized operation for the budget savvy homeowner. PowerTouch Rechargeable uses Simplicity motors and components.

### PowerTouch Rechargeable Shades Operation

Press the up or down button on the pendant to raise or lower the shading to your desired position. When the shading is fully lowered to the factory programmed lower limit, the bottom rail will be set in the level position.

No programming is required with PowerTouch™, all programming is set at the factory. Upper and lower limits easily can be adjusted in the field if desired. Please refer to the installation instructions at [comfortex.com/comfortex-dealers](http://comfortex.com/comfortex-dealers). Favorites position can be programmed on-site.

### PowerTouch Rechargeable Surcharges

See page 112.

### PowerTouch Appearance

- The PowerTouch Rechargeable wand and pendant is attached to the head rail and requires no additional mounting.
- The wand and pendant hangs down the front of the shades from the head rail. The wand does not touch the fabric.
- Pendant is 2½" long.
- The pendant does not need to be mounted to the wall to operate the shade.



### PowerTouch Rechargeable Color Options

- Shadings with Black or Oil Rubbed Bronze hardware will be built with black wand and pendants standard. All other colors will use white wand and pendants.



White



Black Shown with Plug-In Charger

### PowerTouch Wand and Pendant Location

The standard location for the wand and pendant is on the right. Please specify location when ordering.

### PowerTouch Rechargeable Wand Length

The standard length of the wand will measure the indicated below unless otherwise specified.

Shading Length	Standard Wand Length
Up to 30"	1' (12")
>30" to 52"	2' (24")
>52" to 78"	3' (36")
>78" to 100"	4' (48")
>100" to 120"	5' (60")

- Wand length is in 1 foot increments. 1 foot - 5 foot

### Mounting Requirements for PowerTouch Rechargeable Shadings

- No special installation hardware or wiring requirements are needed.
- The wand and pendant do not need to be mounted to operate the shading.

### Integrated Rechargeable Motor Battery Life

Rechargeable battery is included with the motor.

The average battery charge will last 6-12 months based on an average sized shade raised and lowered once per day. The life of the battery charge will vary based on the type of window covering selected, the size and weight of the window covering and the number of times the shade is operated on a daily basis.



Charging Port



Close-Up

The battery can be recharged up to 500 times. It takes approximately 5 hours to recharge the motor when fully depleted.

### Battery Charger

8.4 Volt charger requires a standard power outlet to recharge the battery. Must specify charger when ordering a Simplicity PowerTouch Rechargeable Shading. The charger plugs into the charger port. The charger is black and comes with a 156" wire. The dimensions are 1" wide x 2½" length x 1¾" deep.



### PowerTouch Rechargeable Shadings Warranty

Please see page 137 for complete warranty information.

# Color Lux® Shangri-La Sheer Horizontal Shadings

## SIMPLICITY INTEGRATED RECHARGEABLE HARDWARE SYSTEM



**Smooth Face**

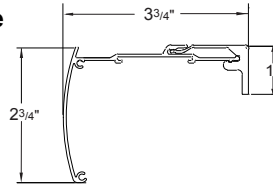

**Fabric Insert**

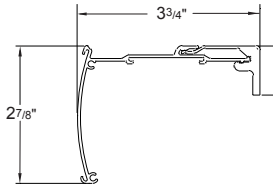

**Smooth Face Designer Cassette Head Rail**

- Depth of rail and bracket: 3 3/4"
- Height of rail: 2 3/4"
- Height of bracket: 1"

**Fabric Insert Designer Cassette Head Rail**

- Depth of rail and bracket: 3 3/4"
- Height of rail: 2 7/8"
- Height of bracket: 1"

<b>Hardware Features</b>	
Standard Designer Cassette	Choose from a printed vane insert or painted Smooth Face rail. Default head rail color is White or Ivory based on shading vane color.
Bottom Rail Color	Color coordinated rail with White/Ivory head rail. Bottom rail will be matched to Oil Rubbed Bronze or Onyx Black when metallic upgrade is selected. With Brushed Nickel Headrail, bottom rail will be coordinated to fabric.
<b>Upgrades</b>	Available for all Designer Cassette Head Rails
Designer Metallic Upgrade (Fabric Insert/Smooth Face)	<ul style="list-style-type: none"> <li>• Oil Rubbed Bronze</li> <li>• Onyx Black</li> <li>• Brushed Nickel</li> </ul>
<b>Mounting Dimensions</b>	
Mounting Dimensions	Designer Cassette Head Rail
Minimum Shallow Mount	1"
Minimum Flush Inside Mount (including brackets)	3 3/4"
Minimum Outside Mount	1"
Minimum Side Mount	1 1/4"
Width Side Mount	48" Max width side mount
<b>Finished Dimensions</b>	
<b>Inside Mount</b>	
	<ul style="list-style-type: none"> <li>• Fabric will measure ordered width less: 1"</li> <li>• Head rail* will measure ordered width less: 3/16"</li> </ul>
<b>Side (End) Mount</b>	
	<ul style="list-style-type: none"> <li>• Fabric will measure ordered width less: 1 1/2"</li> <li>• Head rail* will measure ordered width less: 1 1/16"</li> </ul>
<b>Outside Mount</b>	
	<ul style="list-style-type: none"> <li>• Fabric will measure ordered width less: 5/8"</li> <li>• Head rail* will measure ordered width plus: 3/16"</li> </ul>
<b>Exact (End Cap to End Cap) Mount</b>	
	<ul style="list-style-type: none"> <li>• Fabric will measure ordered width less: 1 3/16"</li> <li>• Head rail* will measure ordered width</li> </ul>
* Head rail measurements include endcaps. Width and length measurements may vary +/- 1/8"	

Please Note: Once ordered and manufactured, the width of the Shangri-La fabric cannot be altered. Comfortex makes deductions to the width depending on the type of mounting indicated. For all mounting types, fabric will measure exactly the length ordered when the vanes are in the closed position.

# Color Lux® Shangri-La Sheer Horizontal Shadings

## SIMPLICITY INTEGRATED RECHARGEABLE HARDWARE SYSTEM

### Simplicity Rechargeable Motors

The Rechargeable Simplicity Motor program features an integrated rechargeable lithium ion battery in the motor casing and is fully concealed by the roller tube.

### PowerTouch Integrated Rechargeable Surcharges

See page 110 for shading standards and page 112 for surcharges and pricing example.

### Simplicity Rechargeable Motors

No special installation hardware or wiring requirements are needed to install motorized Shangri-La Shadings with Designer Cassette Head Rail. No external battery wand is required. See page 125 for mounting information.

### Rechargeable Simplicity Motor Batteries

The battery for the integrated rechargeable simplicity motor system is integrated within the motor casing and is fully concealed by the roller tube.

Rechargeable battery comes fully charged from the factory.

### Integrated Rechargeable Motor Battery Life

Rechargeable battery is included with the motor.

The average battery charge will last 6-12 months based on an average sized shade raised and lowered once per day. The life of the battery charge will vary based on the type of window covering selected, the size and weight of the window covering and the number of times the shade is operated on a daily basis.

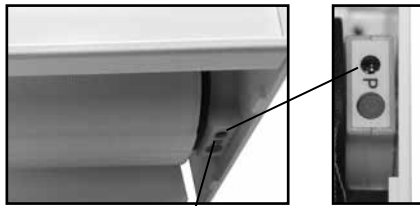

Charging Port

Close-Up

The battery can be recharged up to 500 times. It takes approximately 5 hours to recharge the motor when fully depleted.

### Integrated Rechargeable Motor Battery Charger

An 8.4 Volt charger requires a standard power outlet to recharge the battery. The charger must be specified when ordering an Integrated Rechargeable Simplicity Motorized shade. The charger plugs into the charging port of the motor. Required with Integrated Shading order. Sold separately.



The charger is black and comes with a 156" wire. The dimensions are 1" wide x 2½" length x 1¼" deep.

### Simplicity Motor Hand Held Remotes

**IMPORTANT:** Simplicity Rechargeable Motorized Shadings are programmed at the factory with the "up and down" limits. The shades are **UNLINKED** from the remote so they are not able to operate during shipping. Each shade should be installed **before** linking it to the remote.

#### 5 Channel Remote

The **5 Channel (5C) remote** can operate up to five shadings simultaneously, individually or in groups.

Simplicity (5C) remotes and holders are black or white in color. The remote comes with a holder which can be mounted to a wall for easy storage. The range of the remote is approximately 80 feet.



#### 6 Channel Timer Remote

The **6 Channel (6C) timer remote** combines the functionality of a six channel hand-held control with the convenience of a programmable timer.

- The 6C timer remote allows for 18 different scheduled actions.
- Manual function disables the timer and the remote then operates as a hand held remote.

Simplicity (6C) remotes and holders are available in white. The remote comes with a holder which can be mounted to a wall for easy storage. The range of the remote is approximately 80 feet.



A **14 Channel (14C) remote** is also available. This remote is required for TDBU motorization but can be utilized on all Simplicity motorized shades. See page 29 for more information.

#### Please Note:

- Not all motors run at the same rate of speed.
- Simplicity motors have a "Favorites" or "MY" position setting. If the homeowner wants to set several shadings at the same intermediate position, follow instructions provided with installation manual.
- **WHEN ORDERING THE NEW INTEGRATED RECHARGEABLE, PLEASE ORDER THE NECESSARY BATTERY CHARGER.**

#### Solar Panel Recharge Option

Plugs in to any Simplicity Rechargeable Remote control shade (does not work with PowerTouch). See page 126.

# Color Lux® Shangri-La Sheer Horizontal Shadings

## SIMPLICITY INTEGRATED RECHARGEABLE HARDWARE SYSTEM

### Important Information about Integrated Rechargeable Simplicity Motor Shading Operation and Installation

- Simplicity Motorized Shadings installed into windows with metal casings may have a reduced radio frequency range, or may not operate at all, depending on control.
- Be mindful of when your shade starts to slow down during operation. It is a good indicator the shade needs to be recharged.

### Retrofit Existing Standard Simplicity Motorized Shadings with Rechargeable Batteries

Sheer shadings made with Standard Simplicity Motorization can be retrofitted with the NEW Rechargeable Simplicity Motorization External Battery Wand. The Rechargeable battery wand is 22" long, comes with 10 NiMH batteries, and is white in color. Battery wands are charged at the factory.

To retrofit the rechargeable battery wand to an existing shading with a cassette head rail, you must have at least 24" between bracket centerlines to fit the battery wand. Otherwise, the wand must be placed elsewhere along the window. Wall mounting clips are provided with the wand.

#### Retrofit Ordering Requirements:

- Rechargeable battery wand with clips (one per shade)
- Rechargeable battery charger (one or more per order, or as needed)
- Charging port mounting base (optional)

Please contact customer service for more information. Please note: Retrofit wand does not work with solar panels.



### Simplicity Battery Operated Motorized Shadings Warranty

Please see page 137 for complete Comfortex warranty information.

### Solar Panel Recharge Option

Plugs in to any Simplicity Rechargeable Remote control shade (does not work with PowerTouch)

Provides constant trickle charge to 7.4v Li-Ion Rechargeable battery packs. Does not require direct sunlight, but performs best in regular direct sunlight applications. Will prolong the life of the charge of the 7.4v rechargeable battery packs, and in some applications will maintain charge indefinitely.

Life of charge is subject to application variables such as, size and weight of shade, frequency of use, amount of direct sunlight exposure, etc.





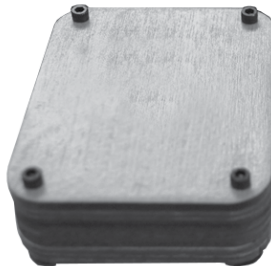

**Simplicity Smart Controller Dimensions**

- Width of controller: 2<sup>3</sup>/<sub>8</sub>"
- Length of controller: 2<sup>15</sup>/<sub>16</sub>"
- Height of controller: 1<sup>1</sup>/<sub>8</sub>"

<b>Simplicity Smart Controller</b>	
	<ul style="list-style-type: none"> <li>• Works with Apple and Android devices</li> <li>• FREE Downloadable Application</li> <li>• Compatible with previously installed Simplicity Remote Controlled Shades</li> <li>• Powered by NEO Smart Blinds App.</li> <li>• Compatible with Amazon Alexa and Google Assistant systems</li> </ul>

**Simplicity Smart Controller**

The Simplicity Smart Controller is a small device that you install in your home that allows you to set automatic opening and closing times for all Simplicity motorized shades as well as the ability to control your motorized shades from a phone, tablet or PC anywhere in world.

The Simplicity Smart Controller will work with any Comfortex motorized shade with Simplicity Remote Controlled motors purchased after 2012.

The Simplicity Smart Controller plugs into a standard electrical outlet and connects to WiFi and sends signals to your shades using the same radio frequencies as a normal remote control.

**How Does The NEO Smart Blinds App Work?**

The app uses WiFi or cellular data to send commands over the internet to the Simplicity Smart Controller.

**Do I Need Any Other Equipment?**

Yes, The location where your shades are installed must have WiFi in order for the Simplicity Smart Controller to work. Additionally, you must have a smartphone or tablet running Android or iOS (eg. iPhone, iPad, Samsung Galaxy S7) and have the NEO Smart Blinds app. installed.

**Why Would I Want A Simplicity Smart Controller?**

There are 2 main ways the Simplicity Smart Controller adds additional value to your motorized shades. First, once all of your shades have been added you can use your smartphone as a single remote for all of your shades. It will work anywhere you are regardless of distance from the shade. Secondly, the device allows you to set schedules so your motorized shades automatically open and close without needing to do anything on a day to day basis.

**Do I Need To Buy More Than 1 Controller?**

The normal use for the Simplicity Smart Controller is to plug it in out of the way and forget it. Since it has roughly the same range as a remote you will want enough devices to allow all shades to be operated without moving the controller. So depending on the layout of the home and location of the shade, you might want multiple devices to have convenient full home coverage.

**How Far Is The Range Of A Controller?**

You should see a range of approximately 150 ft. However this number might be less depending on the layout of your home. In general we recommend one per a floor of a normal sized home.

**Can I Control My Shades From Multiple Devices?**

Yes! You can download the NEO Smart Blinds app onto multiple devices, After installing the app on a new device simply log in with the same email/password on each device and you will have access to control your shades.

**Can It Be Used With Already Installed Shades?**

Yes! Simply follow the directions in the NEO Smart Blinds app to add a shade. At the pairing step you can put the shade in pairing mode using the primary remote control for it (or by accessing the button on the shades motor). Adding the shade to the NEO Smart Blinds app will not affect the normal remote operation.

**How Much Does The NEO Smart Blinds App Cost?**

The app is a free download, However you must have at least one Simplicity Smart Controller to serve as a bridge between the app and your Shades. See page 112.



# Color Lux® Shangri-La Sheer Horizontal Shadings

## GENERAL INFORMATION

### Certified Fabrics | GREENGUARD® Fabrics

GREENGUARD Environmental Institute has established performance based standards to define goods with low chemical and particle emissions for use indoors.

The Shangri-La fabrics have the passed GREENGUARD Indoor Air Quality Certified® certification program for low emitting interior building materials, furnishings, and finish systems.

### Flame Resistance

Shangri-La fabric may be processed with a topical treatment to resist flames and adhere to strict flammability codes. For more information, contact Customer Service at (800) 843-4151.

### UV Protection

Ultraviolet light, entering the home as sunlight, damages furnishings. In time it fades wood floors, furniture, upholstery, draperies, carpeting and artwork. Prolonged exposure to sunlight causes natural, undyed fabrics to turn yellow, weakening their fibers and making them look old and worn prematurely.

The right window covering can be very effective in blocking ultraviolet rays. Such effectiveness is measured in terms of a "% UV blockage" rating. The higher the rating, the greater the UV protection.

Shangri-La fabrics have the following UV Protection ratings:

Light Filtering Fabrics	Open Vanes	87%
Room Darkening Fabric	Open Vanes	88%
All Fabrics	Closed Vanes	99%

### Vane Closure

Shangri-La vanes are not designed to close tightly. The inherent nature of the fabric will cause a slight increase in the distance from the front sheer to back sheer as you move further down the shading. These vanes do not form a perfect seal against light leakage which is most visible toward the bottom of the shading. Vane overlap ensures that privacy is not compromised.

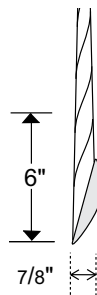

Vane closure is measured as the distance between the front and rear fabric sheers 6" up from the lowest point of the bottom rail, with the shading fully lowered and the vanes closed.

On light filtering fabrics, the maximum distance from the front sheer to the back sheer when closed is equal to or less than 5/8" for shadings under 60" and 7/8" for shadings longer than 60". On room darkening fabrics, the distance is 5/8" regardless of shading length.

On all 3" fabrics, the distance is equal to or less than 1".

### Vane Opening and Visibility

Vaness on the three styles of Shangri-La fabrics open to slightly different degrees. Consequently, there are variations in visibility through the shadings when the vanes are tilted to their maximum open positions. The variations among the products are shown in the below illustration when looking through the shading 1/4 of the way up from the bottom.

3" Fabrics

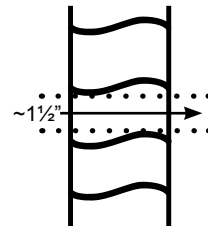

### Magnetic Hold-Down Brackets

Optional magnetic hold-down brackets secure the bottom of the shading to prevent swaying. Please specify when ordering.

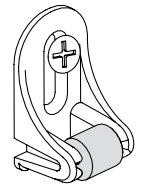

### Extension Brackets

Extension or "L" brackets are available to project the back of the shading from the mounting surface. The extension brackets for Designer Cassette head rail projects it 3".

### Spacer Blocks

Spacer blocks project the shading 3/8" from the mounting surface. Use spacer blocks to obtain clearance when obstructions, such as window cranks or door handles, obstruct the movement of the shading.

### Leveling Shangri-La Sheer Shadings

Shangri-La Window Shadings are leveled and weighted in the factory. When installed level, the fabric will not skew when raised. If the head rail is not installed level, skewing can occur that can damage the edge of the fabric. Be sure to follow the installation instructions carefully to ensure correct and balanced operation.

### Child Safety

Please see page 133 for child safety information.

# Color Lux® Shangri-La Sheer Horizontal Shadings

## GENERAL INFORMATION

### Measuring Instructions for Sheer Shadings

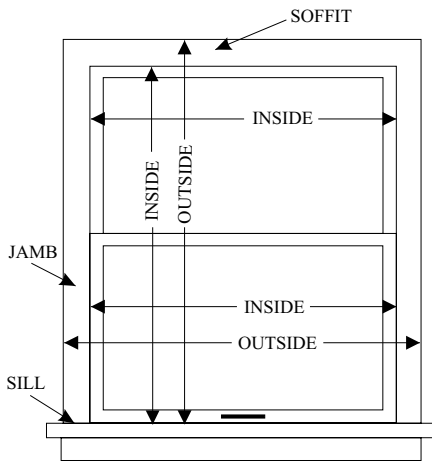

### Important Measuring Guidelines for Sheer Shadings. Comfortex accepts measurements down to 1/16" increments.

Precise width and length measurements are critical. Fabric width cannot be altered after the shading is fabricated.

Please use a metal tape measure for accuracy.

The head rail must be installed perfectly level to ensure smooth operation. On an inside mount, it is recommended that you check to see that the mounting surface is level and consistent. If your soffit needs to be leveled, this should be done before measuring.

#### Inside Mount

Measure across the width of your window opening in three different places - top, middle and bottom. Measurements should be taken within the window jamb. Provide the smallest of the three measurements to Comfortex. Be exact. Comfortex will make the necessary deductions to fit the window opening.

Measure the length of the window opening from the underside of the soffit to the surface of the window sill in two places - use the smallest of these two measurements.

#### Outside Mount

Measure the exact width and length of the area to be covered. On the width, allow at least 1 1/2" of an overlap on each side. An overlap of 3" on each side is recommended. Be sure to take into consideration any obstructions such as window trim, molding, locks and window cranks.

#### Side Mount

**Side mount is not available with DoorStyles Shadings.**

Shangri-La may be side mounted using "L" brackets. For side mounts, follow the instructions for inside mounts. An additional 1/2" will be taken off the standard inside mount deduction to allow room for the "L" brackets.

The maximum shading width utilizing the side mount option is 48".

### Skew Adjusting Bottom Rail

After installation, windows that are not square and level may cause the shadings to shift to one side as it rolls up, requiring adjustment of the bottom rail. If the brackets are not level it may be necessary to adjust the bottom rail weight.

- To access the bottom rail weight, release the weight clip on the bottom rail by using a flat blade screwdriver. Insert it into the weight clip in the bottom rail and turn clockwise.
- Move the weight in 1" increments toward the side where the fabric is gathering.
- Secure the weight clips in position by turning them counterclockwise after making the adjustment.

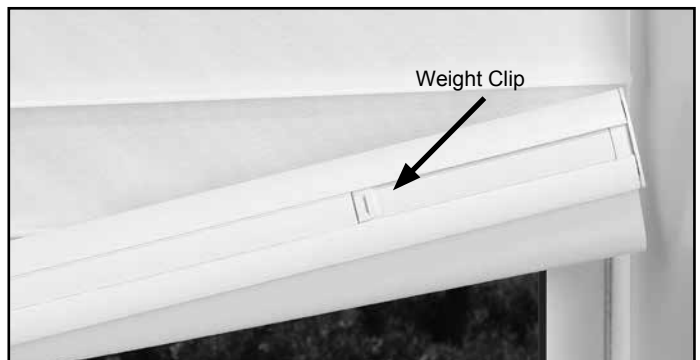

### Cleaning and Care

Shangri-La Shadings are made from a sturdy, knitted polyester fabric which can be feather dusted or vacuumed at a low setting. Spots or stains can be lightly rubbed clean with a damp sponge and mild soap. To avoid discoloration of the material, we recommend against the use of chemical cleaners.

Precautions should be taken to reduce exposure to harsh environmental elements, such as salt air. Continuous exposure to salt air through open windows and doors will accelerate fabric deterioration over time.

**Important:** Do not clean the fabric using electrostatic wipes such as Swiffer® or Pledge Grab-It®.

### Ultrasonic Cleaning

Shangri-La Shadings can be ultrasonically cleaned. Adco OnSite Fabricare provides shading and blind cleaning services. For more information, visit [www.onsitefabricare.com](http://www.onsitefabricare.com). Comfortex acknowledges these cleaning methods as being safe and effective. We cannot attest to the quality of equipment or services provided by any independent cleaning facility.

For additional advice on care or cleaning, please contact the Comfortex Technical Service Department at 800-843-4151.

## COLOR LUX® GENERAL INFORMATION



**COLOR LUX**  
*Designer Cellular & Roller Shades*

# Color Lux® Shades

## GENERAL INFORMATION

### Cut-Outs, Scotchgard Protection, Certified Fabrics and Highlights Cornice Valances

#### Cut-Outs

Cut-outs are available with all cellular fabrics. Cut-outs are \$55.00 per side and are subject to approval by the Comfortex Technical Service department.

There are no limits on cut out lengths. There are limits on cut out widths:

Cellular shade widths 18" or less 3" maximum width

Cellular shade widths greater than 18" 5" maximum width

#### Scotchgard™ Protection

Scotchgard™ Protector is available with Color Lux Cellular, Roller and Panel Track Shades.

Scotchgard™ keeps your shades looking newer, fresher and cleaner longer.



A combination of the latest advances in stain release and repellency provides exceptional stain protection. Spills wipe away easily and most dirt and stains lift out when cleaned.

#### Certified Fabrics

GREENGUARD Indoor Air Quality Certified® Fabrics  
The GREENGUARD Environmental Institute has established performance based standards to define goods with low chemical and particle emissions for use indoors.

Color Lux Linen Weave fabrics have received GREENGUARD Indoor Air Quality Certified® certification for low emitting interior building materials, furnishings, and finish systems.

#### Highlights Cornice Valances

Elevate your windows to a whole new level of design with the Highlights Cornice Valance. Coordinate with other design elements in your room and add a finishing touch to the top of any window treatment. The Highlights Cornice Valance is versatile and beautiful at a price point that won't leave you wondering how to cover the rest of your windows!

Choose from any color in the Color Lux Roller line and customize the valance with our 7 available return sizes to best fit your application.

Easy assembly and quick installation, with the Highlights Cornice Valance, more beautiful windows are within your reach.

### Shade Stack Heights

Measurements are in inches. Shade stacking heights applicable when the shade is in the fully raised position.

	48"	72"	84"	96"
<b>Standard Rectangular</b> (Includes head and bottom rails)	2	2 $\frac{3}{8}$	2 $\frac{3}{8}$	2 $\frac{3}{8}$
<b>Top Down - Bottom Up</b> (Includes head, middle and bottom rails)	2 $\frac{3}{8}$	3	3 $\frac{1}{4}$	3 $\frac{3}{8}$
<b>Cord Loop</b> (Includes head and bottom rails)	3	3 $\frac{3}{8}$	3 $\frac{3}{8}$	3 $\frac{3}{8}$
<b>Motorization</b> (Includes head and bottom rails)	3	3 $\frac{3}{8}$	3 $\frac{3}{8}$	3 $\frac{3}{8}$

	48"	60"	72"	84"
<b>Cordless Ultra</b> (Includes head and bottom rails)	3	3 $\frac{1}{4}$	3 $\frac{3}{8}$	3 $\frac{3}{8}$
<b>Cordless Ultra Top Down - Bottom Up</b> (Includes head, middle and bottom rails)	3 $\frac{3}{8}$	3 $\frac{3}{8}$	4	4 $\frac{1}{4}$
<b>Cordless Lift &amp; Lock</b> (Includes head and bottom rails)	2 $\frac{3}{4}$	3 $\frac{1}{8}$	3 $\frac{3}{8}$	3 $\frac{3}{8}$
<b>Cordless Lift &amp; Lock Top Down - Bottom Up</b> (Includes head, middle and bottom rails)	3 $\frac{3}{8}$	4 $\frac{1}{4}$	4 $\frac{1}{2}$	4 $\frac{3}{4}$

<b>! WARNING/ADVERTENCIA</b>	
5.1.3	Rev. 5/18    Print 5/18
	<p>Window Blind Cord Can <b>STRANGLE</b> Your Child. To prevent strangulation, purchase cordless products or products with inaccessible cords.</p> <p>La cuerda de la persiana puede <b>ESTRANGULAR</b> a su niño. Para evitar el estrangulamiento, compre alternativas cuerda o productos con cuerdas inaccesibles.</p>

### Child Safety

Comfortex has a long history of designing new child-safety products and is proud to provide a leadership role in cooperating with the Consumer Product Safety Commission (CPSC) for the development of policies and guidelines for the industry by serving on the WCMA Standards Development Committee.

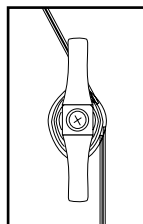

Cord Cleat



Cord Tensioner

All Comfortex products have been fully tested and proven to comply with the current WCMA Standards for safety of corded window coverings.

Be aware that it is possible for children to become entangled in window covering cords. To reduce the risk of accidents, all cords must be kept out of the reach of children.

A cord cleat or cord tensioner is an effective way to implement this essential precaution. Please use them.

To mount the cord cleat at a safe height, take into account furniture or other objects upon which a child may climb. Then, after the use of the blind, simply wrap the excess cord around the cleat.

### Cleaning and Care

While beautiful and pleasing to the eye, all Comfortex products are designed to be durable, easily cared for and easily cleaned. Our non-woven fabrics are inherently anti-static and repel dust, but occasional feather dusting or vacuuming may be necessary to keep the fabrics clean and bright. Comfortex Color Lux Cellular fabrics may be ultrasonically cleaned.

Our light filtering and room darkening fabrics are inherently anti-static and repel dust, but occasional cleaning may be necessary to keep the fabrics clean and bright. The fabric can be dusted with a soft, clean cloth, feather duster or lightly vacuumed with a soft brush attachment. Spills and stains can be lightly blotted with a cloth or damp sponge. More difficult stains may require soaking in water with mild soap. For this, remove the shades from the window and soak in warm water. Complete immersion of hardware is not recommended.

DO NOT submerge the Cordless Ultra head rail in water. When damp, lay flat to dry or place back in window and raise tightly to recrisp pleats. Please test any stronger cleaners on an unobtrusive portion of the shade before using.

For additional advice on care or cleaning, please contact our Technical Services Department.

### Scotchgard™ Treated Shades

The following are the recommended cleaning and care instructions for window treatments with fabric treated with Scotchgard™ Protector.

- Gently blot liquid stains immediately with a clean, white cloth.
- If stain remains, prepare a solution of ¼ teaspoon of clear, non-bleaching dish detergent mixed with 1 cup of lukewarm water. Dampen a clean white cloth and gently blot the stain.
- Do not over wet the fabric or excessively rub the stained area.
- See the Installation and Care instructions for complete details.

For additional assistance with stain removal, call the Scotchgard™ Protector Service Center at 1-800-433-3296. Customer Care representatives are available Monday through Friday, 8am to 6pm CT.



## Measuring Instructions

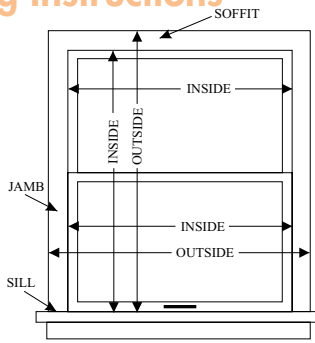

Comfortex accepts measurements down to  $\frac{1}{16}$ " increments.

### Inside Mount

Use a steel tape to measure the opening at three different places, and use the narrowest dimension when ordering. Be exact! The factory will make the shade  $\frac{3}{8}$ " narrower so it will not rub against the window casing. Measure the height of the window from the top (soffit) down to the sill.

### Outside or Ceiling Mount

Use a steel tape to measure the exact height and width of the area to be covered. It is recommended that the shades overlap the window by at least  $1\frac{1}{2}$ " on each side. When installation has no sill, allow the shade to overlap the bottom of the window casing by at least  $1\frac{1}{2}$ ". Shade fabric will measure width indicated on the order form.

## Measuring for Specialty Shapes

Templates are required with some specialty shade orders. Consult the individual product sections of this guide for specifics regarding accurate measurements and mounting information.

### Arches and Quarter Round Circles

- Measure the window height and width appropriately for an inside or outside mount.
- With perfect arches, the height will be one half the width. With perfect quarter rounds, height will equal width. If the arch or quarter round is perfect, **a template is not required.**
- Windows with imperfect arch measurements do not maintain the height/width relationship. Templates **are required** for these windows.

### Trapezoids

- Measure the window height and width appropriately for an inside or outside mount. For outside mounts, remember to add the desired amount of overlap.
- Either the top or bottom of the shade is sloped or angled.
- Measure all four sides for accurate fabrication. Provide all measurements. **Templates are not required.**
- The slope angle must be measured with a protractor. Slope is the angle between slope and a horizontal line. The maximum slope is 30 degrees.

### Octagons

- **Templates are required** and must be cut out of brown craft paper.
- Measure the window height and width appropriately for an inside or outside mount. Be sure to measure the width at the shade's widest point.
- Provide the width, length and the length of one side when ordering.

## Making the Perfect Template

Tape brown craft paper over the window opening. Be sure to allow plenty of overlap and check to see that the paper is smooth and pulled taut. Do not use newspaper as the ink can rub off on fabric. Do not use paper that has been folded. Notice the outline of the framework superimposed on the template as the light filters through the window. You may create the template in one of two ways:

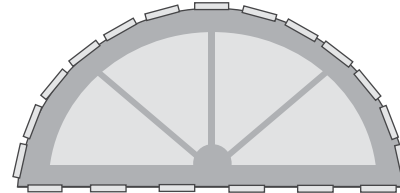

Trace the outline of the window with a pencil and continue along the side of the window frame. Once the window is completely traced, remove the craft paper from the window. Cut out the traced shape with a pair of scissors.

You may choose to skip tracing the window outline with a pencil and cut out the shape immediately with a razor knife.

Once your template is cut, double check its width and height with your initial measurements. Test the template by placing it in the window. Check for light gaps, uneven cutting of curves etc. Trim or remake if necessary.

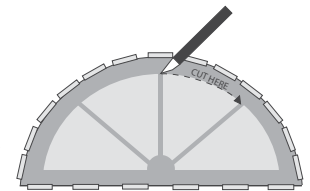

With arch top shades, fold the template in half. Check the outline of the curve for smoothness, light gaps and curve continuity. Place the template in the window and check it for light gaps or uneven cutting of curve. Trim or remake it if necessary.

On the front of the template, mark the shade measurements along with your company name, account number, sidemark, shade style and color. Be sure to indicate inside or outside mount, the room side and which ends of the template are top and bottom. Do not take any deductions on inside mount shades. The factory will make all necessary allowances for inside mounts.

**Remember:** The quality of the finished shades depends heavily on the quality of the template supplied. Do not hesitate to remake a template if you feel uncomfortable of the quality of your first attempt.

**Template Kits:** Comfortex offers template kits which includes brown craft paper, razor knife, instructions and order form. Please contact Customer Service or visit [www.comfortex.com](http://www.comfortex.com) to order. Stock number: 751000



# Color Lux® Shades

## GENERAL INFORMATION

### Conditions of Sale

All Comfortex products are custom fabricated to your exact specifications. We cannot accept responsibility for errors in ordering or cancellations and charges after the order is in production.

### Policies

Our policies are designed to provide a guide for doing business with Comfortex. Our first priority and number one policy is to provide the highest level of service and total satisfaction.

### Freight Policy

#### Fabricated Shades/Blinds

Comfortex will ship all orders for fabricated shades or blinds freight free via UPS, FedEx Ground or other similar method within the Continental US.

**Transportation Surcharge:** A \$5.50 per unit transportation surcharge will be added to all fabricated product orders shipping within the Continental US; including shades/blinds, vane packs, individual vanes, tracks, valance and cut yardage orders. Exception: Vertical Sheer Shadings, Ovation Cellular Slider and Envision Panel Track system will incur a \$15 per unit transportation surcharge up to 96”.

**Oversized:** In addition to the transportation surcharge, a \$45 per unit Common Carrier surcharge will be added to all fabricated products shipping within the Continental US, including shades/blinds, Vertical Sheer Shadings, Ovation Cellular Slider, Envision Panel Track system, valances, vane packs, individual vanes, tracks, and cut yardage orders with widths of over 96 inches.

**Hawaii:** Shipments to Hawaii will incur a freight charge of \$26.00 per unit when shipped from within the Continental US. In Addition, a \$132.00 per unit Common Carrier surcharge for oversized shades/blinds (over 96”) will be added to orders shipping to Hawaii.

**Alaska:** Shipments to Alaska will incur a \$26.00 per unit transportation surcharge when shipped from within the Continental US. In addition, a \$132.00 per unit Common Carrier surcharge for oversized shades/blinds (over 96”) will be added to orders shipping to Alaska from within the Continental US.

**Canada:** Shipments to Canadian Dealers will incur a \$7.75 per unit transportation surcharge when shipped from within the Continental US. In addition, a \$75.00 per unit Common Carrier surcharge for oversized shades/blinds (over 96”) will be added to orders shipping to Canada from within the Continental US.

**Other Countries:** All US Dealers requesting to ship orders outside the USA, must provide a Freight Forwarder for Comfortex to ship to within the Continental US. Comfortex cannot ship directly to your customers located outside USA.

### Components and Fabric

Comfortex will prepay all freight charges on shipments of component and fabric orders over \$3,500 in value within the Continental US. Fabric and component orders less than \$3,500 will be subject to freight charges.

### Shutter Components and Tools

Comfortex will prepay all freight charges on shipments of stock component and tool orders exceeding \$20,000 in value, within the Continental US only. All orders less than \$20,000 will be subject to all freight charges. Customers can elect a carrier of choice and receive a freight bill directly from the carrier or Comfortex will select a carrier and invoice the customer for the freight charges. Comfortex makes every effort to provide the most economical carrier and shipping method possible.

### Charged Marketing Materials

All charged marketing materials will incur freight charges. Marketing materials may ship on separate days, from different locations. Freight charges are calculated per package, not per order.

### Specifications

All Comfortex products are designed and tested to perform as intended within established, published parameters. Requests for “custom fabrication” of products outside of our published specifications may be considered, but are at the discretion of the Comfortex Technical Services department. Restrictions and additional charges apply.

**Download installation instructions, order forms or additional price list copies on the Comfortex OnDemand Library or [www.comfortex.com/comfortex-dealers](http://www.comfortex.com/comfortex-dealers) in the Dealers Resource Center.**

# Color Lux® Shades

## GENERAL INFORMATION

### Scotchgard™ Warranty

Comfortex Window Fashions provides a limited warranty for fabrics treated with Scotchgard™ Protector against permanent stains for a period of 1 year from the date of original purchase.

This warranty excludes conditions or damages resulting from accidents, alterations, exposure to the elements, and exposure to any and all natural and manufactured excessive heat sources, or failure to follow the Installation and Care instructions. This warranty also excludes fabric submerged in water or cleaning solutions, or treated with household products that may alter or deplete the effectiveness of the treated fabric. In addition, the following types of stains are excluded from this limited warranty: pet stains, bodily fluids, stains caused by wine, bleach, plant fertilizers, acne medication, misuse or abuse. This warranty is not a cleaning contract and does not cover the cleaning of fabrics that are soiled or discolored through daily use. This warranty coverage is limited to residential use and is not transferable.

The following are the recommended cleaning and care instructions for window treatments with fabric treated with Scotchgard™ Protector.

- Gently blot liquid stains immediately with a clean, white cloth.
- If stain remains, prepare a solution of ¼ teaspoon of clear, non-bleaching dish detergent mixed with 1 cup of lukewarm water. Dampen a clean white cloth and gently blot the stain.
- Do not over wet the fabric or excessively rub the stained area.
- See the Installation and Care instructions for complete details.

For additional assistance with stain removal, call the Scotchgard™ Protector Service Center at 1-800-433-3296. Customer Care representatives are available Monday through Friday, 8am to 6pm CT.

Should the results of the cleaning and care instructions not result in the removal of permanent stains covered by this limited warranty, Comfortex will retreat or replace the fabric, at it's discretion, for a period of 1 year from the date of original purchase. Customer must provide proof of purchase and provide proof the stain occurred during the warranty period. Shipping and handling costs to send the window treatment back to Comfortex are the responsibility of the customer.

This warranty gives you specific legal rights, and you may also have other rights which vary from state to state.

### Sheer Horizontal Shadings Warranty Information

Knitted fabric may experience minor weave variations due to heat, humidity and other room conditions. These variations can result in light bowing, puckering and dimpling of the Shangri-La material. This is considered normal and does not constitute a failure in either workmanship or materials. The possible variations are minor and have been shown through case study not to detract from the beauty of the product.

### Warranty Information Regarding the Braided Cord on Shangri-La Sheer Shadings with Designer Cassette Hardware:

Designer Cassette Shadings built with a braided cord do not have a reverse roll stop. If a Shangri-La Shading with the Designer Cassette Head Rail is raised above 24" in the reverse roll mode, there is a possibility of the fabric rubbing on the head rail. Comfortex reserves the right NOT to warrant wear and tear of fabric if damaged by roll-up in excess of 24".

### Color Lux Cellular, Roller, Panel Track Shades and Sheer Horizontal Shadings Warranty Information

Comfortex warrants that its window treatments will be free from defects in materials and workmanship for as long as the original residential purchaser owns the product, provided that the product was installed properly and in accordance with the installation instructions. The Limited Lifetime Warranty is extended to the original residential purchaser only, in the original window for which it was installed.

The Warranty does not include any conditions or damages resulting from accidents, alterations, misuse, abuse, misapplication, improper handling, installation, repairs, operation, cleaning, exposure to any and all natural and manufactured excessive heat sources. (Excessive heat sources include, but not limited to; magnification of sun light through cubes of glass, heaters of any kind, ovens, candles, lighting fixtures, etc.) This warranty does not cover variation in fabric color, grain, or texture in natural wood products nor excessive warping of wood slats in high humidity areas. Loss of pleating is not covered if the product is not being cycled (held in the raised position a portion of the time). Normal wear and tear is not covered.

All moving parts, such as cords and strings ( internal and external), will eventually wear out and fabric may fray. Comfortex considers these things as normal wear and tear and will carry a three year Limited Warranty. All fabric, including fabric vanes, panels, inserts, and shades carry a five year Warranty. Fabric cell separation is covered for a lifetime. See Comfortex Standard Return and Repair Policy for more details.

This Limited Warranty does not cover transportation costs to and from the retailer, costs of removal, re-measure, reinstallation of product, or any incidental or consequential damages.

If a Comfortex product is found to be defective in materials or workmanship, we will, at our discretion, repair, replace or refund the cost of a product which fails to conform to this Limited Warranty. Colors vary from lot to lot and may not exactly match sample swatch, sample book, or previous purchases. Discontinued components or color selections will be replaced with the closest equivalent current product. This shall be your sole remedy under this Limited Warranty.

To obtain service, contact the Dealer from whom you purchased the product.

This Warranty is exclusive and in lieu of all other obligations, liabilities or warranties. In no event shall Comfortex or its licensed fabricators or distributors be liable for incidental or consequential damages, or for any other damage, loss or expense, cost or fee associated with such damage. In some states, exclusions for incidental or consequential damages are not allowable. Comfortex Dealers and Fabricators must use safety devices supplied by Comfortex in accordance with Window Covering Safety Counsel guidelines.

This Warranty gives you specific legal rights, and you may also have other rights, which vary from state to state. Policy is subject to change without notice.

This Limited Warranty is exclusive of commercial use. Contact Comfortex Technical Service for more information. No agent, representative, dealer or unauthorized employee has the authority to increase or alter the obligation of this Warranty.

This Limited Warranty supersedes any previous versions.

## Motorized Color Lux Shadings/Shades Warranty

### Standard Simplicity and Simplicity Rechargeable Motors

We offer a 5 year warranty on all motors and controls. Specifically, we warrant the Simplicity motors and controls to be free from defects in material and workmanship under normal and proper use for a period of 5 years commencing with the date stamped on each product. If the Simplicity product fails within this 5 year period, we will repair or replace it free of charge through your end product supplier.

## Color Lux Color Warranty

Comfortex utilizes state of the art technology to provide you Color Lux Shades within 2 Delta-E (DE) of the sample fabrics found in the Color Lux Sample Book. When viewed under different lighting sources such as fluorescent, incandescent, halogen, ultraviolet and others, fabrics may appear different to the eye. Comfortex utilizes the worldwide lighting standards of Daylight 65 (D65) as our official standard for measuring and qualifying color accuracy, because D65 daylight bulbs best represent actual "daylight" illumination. Slight color variations (under 2 DE) are within established industry standard and should be expected.

This warranty is in addition to Comfortex limited lifetime warranty.

©2019 COMFORTEX CORPORATION

™ is a trademark of Comfortex Corporation. ® is a registered trademark of Comfortex Corporation. Scotchgard, 3M and the Plaid Design are trademarks of 3M. The GREENGUARD INDOOR AIR QUALITY CERTIFIED Mark is a registered certification mark used under license through the GREENGUARD Environmental Institute. Energizer® is a registered trademark of Energizer Holdings, Inc. . Ovation™ Cellular Slider is covered by one or more of the following U.S. Patent Nos.: 4,862,941, 4,858,668, 4,915,153, D346,032, D324,108, 4,450,027, 4,631,108, 4,603,072, 5,690,778, 5,664,773, 6,319,586, 5,482,750, 5,601,885 and 4,631,217. Karma-Light™, Cordless Ultra™, Sunset™, and Ovation™ are trademarks of Comfortex Corporation. Other U.S. and foreign patents pending.



Midwest  
Designer  
Supply

**1-888-523-2611**

**Midwest Designer Supply, Inc.  
N30W22377 Green Road Ste C  
Waukesha, WI 53186  
(262) 523-2600  
Fax (262) 524-1007  
[www.midwestdesignersupply.com](http://www.midwestdesignersupply.com)**

***MDS - your one source for window fashions.***